



GLOBAL  
FINISHING  
SOLUTIONS



# Batch Oven

## Owner's Manual

**Document Number:** 239-080 rev 4  
Publication date 01/24/2022

*Read and keep this manual for future reference. All personnel operating the equipment described in this manual should review and understand all instructions before use.*

# Table of Contents

Introduction .....	5
About Global Finishing Solutions LLC .....	5
Contacting Global Finishing Solutions .....	5
Target audience .....	5
Conventions used in this manual .....	6
Safety notices .....	6
Information notices .....	6
General safety .....	7
Oven safety .....	10
Batch Oven description .....	12
Preparing for installation .....	13
Accepting delivery of your oven .....	13
Gathering required documentation .....	14
Confirming site requirements .....	15
About the Design Drawings document .....	16
Page elements .....	16
General Arrangement (GA) drawing .....	18
Page types .....	19
Installation tools and equipment .....	20
Required tools .....	20
Recommended equipment .....	21
Installation best practices .....	22
Unpack in stages .....	22
Follow assembly guidelines .....	23
Installation procedure .....	24
Install the oven structure .....	24
Install the heater box .....	26
<i>If applicable:</i> Install the heater box on top of the oven .....	26
<i>If applicable:</i> Install the heater box on the floor .....	26
Build the end and side walls .....	27
<i>If applicable:</i> Assemble the oven floor .....	27
Assemble the oven ceiling .....	27
Install the product door .....	28
Install the internal discharge duct assembly .....	28
Install the exhaust fan and exhaust ductwork .....	29
Install and wire the oven control thermocouple .....	30
<i>If applicable:</i> Install the gas piping .....	30
Install electrical wiring .....	30
Complete the Customer Pre-Startup Checklist .....	31
Startup tools and test equipment .....	32

Hand tools .....	32
Test equipment .....	32
Optional equipment .....	32
Commissioning and startup procedure .....	33
Adjust the internal discharge duct nozzles or bend tabs .....	33
<i>If applicable:</i> Bend tabs .....	33
<i>If applicable:</i> Nozzles .....	34
Make sure airflow switches are plumbed correctly .....	35
Oven burner settings and gas train components .....	37
Batch Oven burner settings .....	37
Overview of gas train components .....	38
Verify combustion blower air damper position .....	38
Verify burner speed settings .....	40
Verify burner ignition speed .....	40
Verify burner high fire speed .....	41
Create a parameter backup on the flame safety controller built-in display .....	42
Set high-fire gas pressure .....	43
Exhaust airflow setup .....	45
Balance oven pressure .....	45
Adjust the fresh air intake .....	46
Safety interlock testing procedures .....	47
Check the high gas pressure interlock .....	48
Check the low gas pressure interlock .....	49
Check the flame failure interlock .....	49
Check the high temperature limit interlock .....	50
Check the airflow switch interlocks .....	51
Check the purge timer interlock .....	52
Check the fire protection interlock .....	52
Safety shut-off valve leak test .....	53
Gas train leak test .....	55
Complete the startup documents .....	56
Maintenance schedule .....	57
Troubleshooting .....	59
Control panel .....	61
Flame safety controller appendix .....	62
Create a parameter backup .....	62
Create a backup using the flame safety controller built-in display .....	62
Create a backup using the AZL23 remote display .....	63
Restore the parameters .....	63
Parameter restore on the flame safety controller built-in display .....	63
Parameter restore on the AZL23 remote display .....	63
Adjust burner blower speed settings .....	64
Adjust speed settings with the flame safety controller built-in display .....	64
Adjust speed settings with the AZL23 remote display .....	65
Display the flame signal .....	66
Access the service (Ser) menu .....	66

---

Reset faults .....	66
Phase timing chart .....	67
Flame safety controller fault codes .....	68

# Introduction

## About Global Finishing Solutions LLC

### Leading the Industry in Paint Booth and Finishing System Technology

With decades of experience, Global Finishing Solutions is the leading manufacturer of paint booths and finishing systems for many industries, including automotive refinishing, aerospace and defense, industrial manufacturing, woodworking, and large equipment. By combining high-quality components, strong relationships with paint manufacturers, and our experienced distribution network, GFS provides the best equipment and support to set your business up for success.

## Contacting Global Finishing Solutions

### General information

- Toll-free: 800-848-8738
- Fax: 715-597-2193
- Email: [info@globalfinishing.com](mailto:info@globalfinishing.com)
- Online: [www.globalfinishing.com](http://www.globalfinishing.com)

### Technical support

- Toll-free: 800-848-8738
- Fax: 715-597-8818
- Email: [techservices@globalfinishing.com](mailto:techservices@globalfinishing.com)

### Parts and filters

- Toll-free: 800-848-8738
- Fax: 888-338-4584
- Email: [parts@globalfinishing.com](mailto:parts@globalfinishing.com)

## Target audience

This document is intended for use by trained, experienced equipment installers and maintenance technicians. If you have questions about the installation procedure described in this manual, contact GFS as described above.

## Conventions used in this manual

This section describes how information is presented, organized, and referenced within this manual.

### Safety notices

This manual uses the following standards to identify conditions related to safety hazards and equipment damage.

**Table 1. Safety notices**

Symbol	Description
<b>DANGER</b>	Indicates an imminent hazard that will result in death.
<b>WARNING</b>	Indicates a hazard that can result in serious personal injury or death.
<b>CAUTION</b>	Indicates a hazard that can result in personal injury.
<b>NOTICE</b>	Indicates a situation that can result in equipment or property damage, but poses no risk of personal injury.

### Information notices

In addition to the safety notices described above, this manual uses a boldface keyword to identify certain other types of information.

**Table 2. Information notices**

Keyword	Description
<b>NOTE</b>	Denotes general information that provides additional context or guidance.
<b>Important</b>	Denotes information to which you should pay special attention.
<b>Reference</b>	Directs you to related content in a separate document.
<b>Prerequisites</b>	Specifies other tasks that must be completed or conditions that must exist before you perform the current task.
<b>Scope</b>	Describes limitations to the current task or conditions under which the task applies or does not apply to the procedure.

# General safety

Follow all safety guidelines when assembling, operating, or servicing this product.

## **WARNING**

There are inherent hazards associated with the operation and service of this equipment. For your personal safety, observe all safety information. Failure to observe these safety practices can result in personal injury or death.

## **WARNING**

Operation and maintenance of this product must be performed properly by qualified personnel who observe the warnings in all documentation and notes provided with and on the product.

## **WARNING**

Follow all general standards for installation and safety for work on installations. Follow all good practices for the proper use of lifting tackle and equipment. The use of protective equipment such as safety goggles and protective footwear must be considered.

## **WARNING**

All persons who will operate, service, inspect, or otherwise handle this product must read and understand the safe operating practices, safety precautions, and warning messages in this documentation.

## **WARNING**

The roofs of GFS equipment are not designed or intended to be walked upon or to support weight of any kind. As designed and manufactured, equipment roofs do not meet the minimum requirements of a safe walking and/or working surface under OSHA 1910.22. Under no circumstances should the roof be used by maintenance personnel or others for walking, standing, or storage of any kind. When necessary, roof access should be secured through the use of a properly supported platform that satisfies the minimum load requirements specified by ASCE 7 (Minimum Design Loads and Associated Criteria for Buildings and Other Structures) and ASCE 37 (Design Loads on Structures during Construction). Additionally, personnel should always utilize appropriate fall safety protocols when using an elevated platform. Use of the roof in a contrary manner may result in injury and/or death.

## **WARNING**

Comply with OSHA and NFPA 86 guidelines and with all applicable local electrical, safety, and fire codes and standards.

## **WARNING**

All ovens must comply with NFPA 86.

## **WARNING**

All field wiring provided must comply with local codes or, in the absence of local codes, the National Electrical Code (NFPA 70).

**WARNING**

Electrical installation should be completed by a qualified electrician. Installation must meet all applicable national, state, and local electrical codes.

**WARNING**

Ensure that all electrical components are grounded to a central ground.

**WARNING**

Disconnect and lock out the main electrical service before installing, adjusting, or servicing the product.

**WARNING**

Guards and covers that prevent contact with electrically energized or moving parts are required and must not be removed or left open during operation.

**WARNING**

Local fire and building codes require fire protection. Check with local inspector authorities for requirements.

**CAUTION**

Read and save these instructions before attempting to assemble, install, operate, or maintain the product described. Protect yourself and others by observing all safety information. Failure to comply with instructions could result in personal injury and/or property damage. Retain these instructions for future reference.

**CAUTION**

This manual contains statements that relate to worker safety. Read this manual thoroughly and comply as directed. Operate this equipment in accordance with the guidelines set forth in this manual. It is impossible to list all potential hazards of this equipment. Instruct all personnel involved with this equipment in the safe conduct and operation of the system. GFS recommends that only qualified personnel operate and maintain this equipment.

**CAUTION**

Safety signs, panels, and labels that are normally affixed to the product must be replaced immediately if illegible or missing.

**CAUTION**

New or replacement parts that are installed during repair or maintenance must include all safety signs, panels, and labels as specified by the manufacturer. These must be affixed to the new or replacement parts as specified by the manufacturer.

**CAUTION**

Where applicable, use earplugs or take other safety measures for hearing protection.

**NOTICE**

Per NFPA 86, the product must be installed and serviced only by a trained, qualified service technician. Incorrect installation may void the warranty.



**NOTICE**

If you have questions about the warranty, please contact your distributor prior to contacting GFS.

# Oven safety

## **DANGER**

**Ceiling panel load capacity for installation and maintenance:** You must use temporary platforms that span at least two structural frames for maintenance. **Do not walk on or apply any pressure to explosion relief panels.**

## **DANGER**

Do not place, block, or install any objects on, in front of, or next to any explosion relief panels, ceiling panels, personnel doors, or product doors. The oven is designed to relieve pressure in case of an explosion. Ceiling panels and explosion relief side walls need a minimum of 3 feet (914 mm) and doors must be able to swing full open.

## **WARNING**

All equipment must be operated and maintained in accordance with local, state, and federal (OSHA) requirements governing occupational safety, fire protection, and oven operations. Operators must read and understand GFS and included independent equipment and/or component manufacturer's instructions prior to use. **Disclaimer:** GFS is not responsible for any injury, illness, or property damage that results from not abiding by local, state, or federal (OSHA) requirements that govern occupational safety, fire protection, and oven operations. GFS is also not responsible for any injury, illness, or property damage that is the result of not adhering to GFS and/or independent equipment/component operating, service, maintenance, and/or installation requirement's or directives.

## **WARNING**

Install the oven in compliance with locally enforced codes and standards.

## **WARNING**

A fire suppression system is required by the International Fire Code for class A and B ovens that contain combustible material. A fire suppression system is not supplied with this oven.

## **WARNING**

Do not allow to accumulate on the inside of the oven walls. Remove any accumulation as soon as possible to prevent a possible fire hazard. Use a non-ferrous, non-sparking scraper to eliminate any possibilities of igniting combustible material.

## **WARNING**

Duct the exhaust air from the fan away from the working environment to the outdoors. Do not operate the oven unless exhaust has been ducted properly.

## **WARNING**

Isolate the outdoor vent from air-conditioning intakes, windows, and any other equipment that may recirculate the exhaust indoors.

## **CAUTION**

Become familiar with all controls before operating or servicing this oven.

**CAUTION**

Proper door alignment is critical to the operation of the oven. Ensure that there is equal space around the doors. Move the bottom of the door jamb to the left or right or in and out until the doors are sealed and plumb.

**CAUTION**

If this installation includes vacuum systems or monitoring equipment, install and connect those devices in accordance with the manufacturer's documentation.

**CAUTION**

The purchaser is responsible for advising all employees of the following cautions related to this equipment and its use:

- This oven is not designed for continuous operation, burner systems that operate continuously for more than 24 hours must have an approved flame-sensing system.
- You must cool the oven to below 200 °F (45 °C) before normal shut down or handling parts.
- Parts and oven surfaces may be hot after a cure cycle, handle with caution.

**NOTICE**

GFS recommends storing crates indoors pending installation. If you must store crates outside, protect crates and their contents from moisture to prevent damage to equipment.

**NOTICE**

Install the control panel per NFPA 70 and local codes and standards.

**NOTICE**

Failure to anchor the oven to the floor properly may result in structural damage.

# Batch Oven description

GFS industrial batch ovens (Batch Powder Ovens and Batch Process Ovens) feature excellent heat transfer technology in a compact design. The air distribution system circulates heated air throughout the oven for balanced, uniform temperature and excellent product drying, curing, and treating capabilities.

## NOTE

This oven has been designed to meet the requirements for a class A oven as defined by NFPA 86 standards for ovens and furnaces.

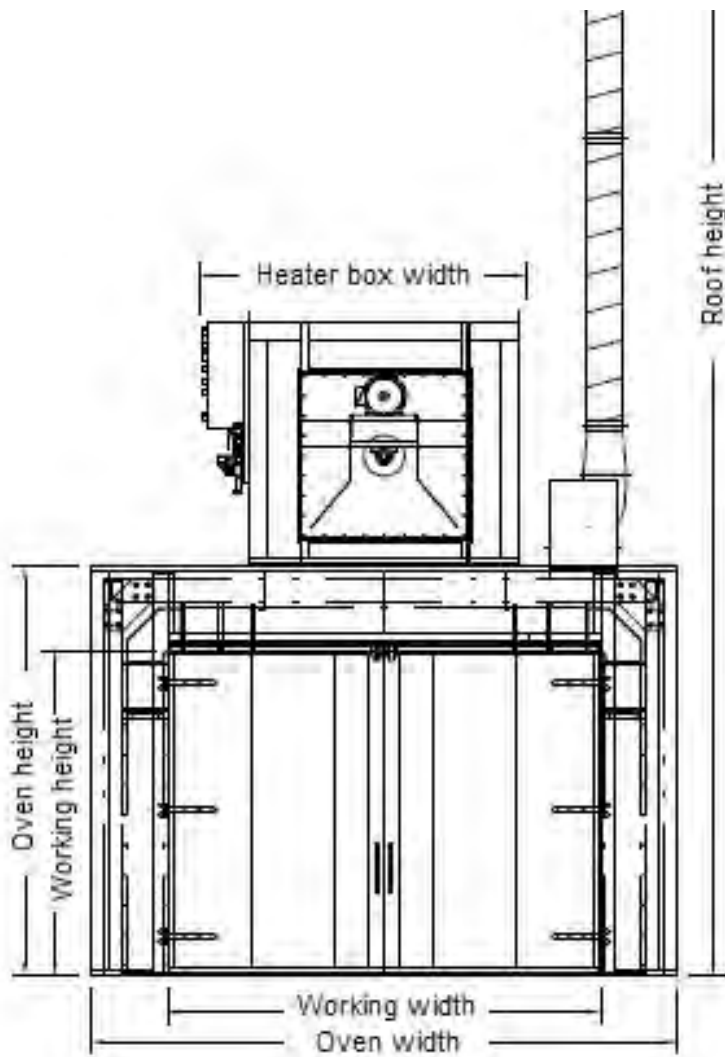

# Preparing for installation

## Accepting delivery of your oven

The oven is delivered unassembled, in multiple crates.

Upon delivery, count the number of crates you received and compare that number to the expected number per the Bill of Lading. Also inspect each crate for any signs of damage during shipment.

### **NOTE**

If you see shipping damage, note it on the freight carrier's paperwork; failure to do so may result in claim denial.

**If any parts are missing or damaged**, contact Global Finishing Solutions at 800-848-8738 to speak to a Technical Service Representative.

### **NOTICE**

GFS recommends storing crates indoors pending installation. If you must store crates outside, protect crates and their contents from moisture to prevent damage to equipment.

## Gathering required documentation

Table 3 lists the location of the hard-copy documents that ship with the oven. Ensure that you can locate these documents and that they are available during the installation procedure.

### NOTE

Certain manuals, project drawings, and the Job-Specific Guide are also provided electronically to distributors via box.com. Many manuals are available for download on [globalfinishing.com](http://globalfinishing.com).

**Table 3. Additional documentation**

Document	Description	How provided
Design Drawings	Provides detailed drawings and instructions for assembling this particular oven	Ships in the "Miscellaneous" box
General Oven Details	Provides supplementary drawings and assembly instructions for common components to be referenced during installation and startup. The details may include drawings that do not apply to this particular oven	Ships with the Design Drawings in the "Miscellaneous" box.
Electrical Drawings	Provides wiring diagrams for electrical components	Ships inside the control panel

## Confirming site requirements

Before beginning the installation procedure, confirm that the site where the equipment will be assembled meets the following requirements:

- The concrete floor beneath the oven must be fully cured and in good repair. Concrete may be exposed to temperatures up to 500 degrees Fahrenheit. These temperatures can cause issues if the concrete is not fully cured prior to oven installation, may damage floor coatings, and can cause oil seepage from old concrete.
- The area is large enough to allow a minimum of 3 feet (914 mm) of clear space on all four sides of the oven. Some exceptions may apply. Check local codes and refer to NFPA guidelines to determine particular space allowances.
- Do not place, block, or install any objects on, in front of, or next to any explosion relief panels, ceiling panels, personnel doors, or product doors. The oven is designed to relieve pressure in case of an explosion. Ceiling panels and explosion relief side walls need a minimum of 3 feet (914 mm) and doors must be able to swing full open.
- There is sufficient overhead clearance for the exhaust ductwork in the area where the equipment is to be located.
- There must be adequate structural support and minimal exposure to power equipment, process equipment, and sprinkler risers.
- The area where you will assemble the oven is free of any corrosive or explosive vapors, such as chlorinated vapors, acid vapors, or volatile solvents.
- The facility in which the oven will be installed must have adequate gas flow and pressure to operate the oven at full burner output. (The gas specification is included with the submittal or provided at delivery.)
- A licensed electrician has verified that the incoming power meets the requirements specified for the equipment. (The power specification is included with the submittal or provided at delivery.)
- The appropriate devices for lifting/rigging are available onsite.
- To avoid electrical noise interference, you must provide a separate, clean power supply for the oven's programmable controllers and/or electronic devices. If you cannot obtain such a power supply, then you must add a line conditioner to ensure proper voltage.

# About the Design Drawings document

Use this manual in conjunction with the provided Design Drawings document. The Design Drawings document defines the overall layout and detailed structure of your particular product. If applicable, it also includes exploded-view diagrams and parts lists for each section of the oven.

## Page elements

Pages within the Design Drawings document contain the following elements:

- **Title block:** The title block is located along the right edge of each page. It contains the model information, drawing identification label or number, the order/serial number, and other information.
- **Model Info:** Contains text that identifies each page within the Design Drawings document, e.g., "Overall Assembly". When the installation instructions refer you to a specific page within the Design Drawings, look for that text in the Model Info field. (For a description of the various page types that might be included in your Design Drawings document, see "Page types" (page 19).)
- **Scale:** If the drawing is to scale, the scale is defined here (e.g., 3/16" = 1' 0"). Otherwise, this field contains "NTS," or "Not to Scale."
- **Drawings:** The main area of each page can contain any or all of these types of drawings:
  - An exploded and/or assembled view of the product or subassembly
  - Additional views or "Detail" drawings
- **Bill of Materials:** Any page that includes a drawing with labeled parts also includes a table that lists each item number with its corresponding part number and quantity.
- **Quantity per Booth:** Pages that show a subassembly of the product and list the quantity provided of that particular subassembly.
- **Notes:** Pages within the Design Drawings often contain notes that provide information about how to install that particular section or subassembly.



**H**

NOTES:

- SEE FINAL DETAIL DRAWING FOR INDIVIDUAL DUCT SECTION ASSEMBLY INSTRUCTIONS.
- INSERT ACCESS PANEL ON BOTTOM OF DUCT SECTION THAT ATTACHES TO HEATER ROD AND INSERT THE SLIPPER ON FACT SECTION. SLIPPER HEATER ROD. THE SCREW SLIPPER INTO HEATER ROD USING A 1/4" X 1/2" TRX SCREW. REMOVE ACCESS PANEL USING THE SAME 1/4" X 1/2" TRX SCREW AND NUTS.
- DO NOT TAUCH SECTION TOGETHER USING 80/20/15/1/8" RODS TO AND NUTS.
- BRING TABS ON DUCTWORK TO KUSHIT ABRUROW AS NEEDED.

**F**

QTY	ITEM	DESCRIPTION	MATERIAL
25	CA 001	DUCT SECTION 6.0000 x 36.0000 x 62.625 in	30 AL
1	CA 002	G DAMP-1187-0881	
1	CA 003	END CAP 11.1875 in x 39.875 in	
2	CA 004	D DOPRA 0100-3000-D1212	
		DUCT BLOW PAK x 15.125	

**G**

QTY	ITEM	DESCRIPTION
1		DUCT SECTION
1		DUCT BLOW PAK
1		END CAP
1		G DAMP-1187-0881
1		D DOPRA 0100-3000-D1212

**I**

**GLOBAL FINISHING SOLUTIONS**  
 12300 HARVARD ROAD  
 OSHEGO, WI 54758 USA  
 800-948-8738  
 globalfinishing.com

GLOBAL FINISHING SOLUTIONS, THE TRADE NAME OF GLOBAL FINISHING SOLUTIONS, INC., IS A REGISTERED TRADEMARK OF GLOBAL FINISHING SOLUTIONS, INC. IN THE UNITED STATES AND OTHER COUNTRIES. © 2018 GLOBAL FINISHING SOLUTIONS, INC. ALL RIGHTS RESERVED.

**D**

**E**

SECTION VIEW A-A

**B**

**A**

**C**

GLOBAL FINISHING SOLUTIONS  
 12300 HARVARD ROAD  
 OSHEGO, WI 54758 USA  
 800-948-8738  
 globalfinishing.com

**A**

MODEL INFO:  
 GFD-00060 (P/TH)  
 INTERNAL DUCT ASSEMBLY

**B**

DATE: 11/15/17  
 DRAWN BY: CSH  
 CHECKED BY: SBT/2019  
 REVISIONS:

**C**

DRAWING NO:  
 R02

FRAMEWORK:  
 S

- A:** Serial number
- B:** Model info
- C:** Drawing number
- D:** Drawings: Main view (exploded and/or assembled)
- E:** Drawings: Detail view
- F:** Bill of materials
- G:** Quantity per booth
- H:** Notes
- I:** Title block

# General Arrangement (GA) drawing

The General Arrangement (GA) Drawing shows the overall dimensions of the oven, installation and startup notes, and equipment operating specifications.

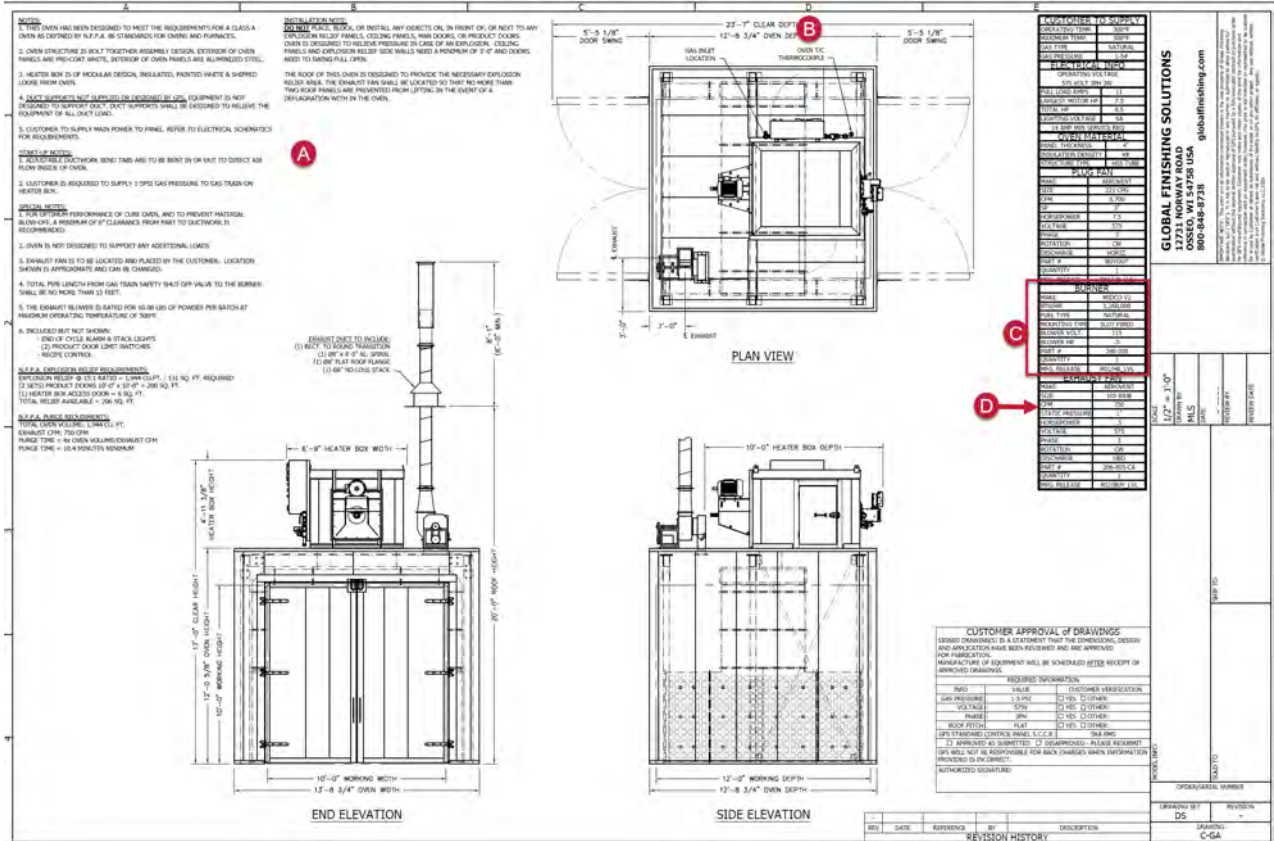

- A:** Oven-specific and general notes for installation and startup
- B:** Oven control thermocouple installation location
- C:** Burner model information
- D:** Exhaust fan information and CFM

## Page types

The Design Drawings document may contain any of the following pages that apply to your particular product.

**Table 4. Page names in the Design Drawing document**

Page name	Description
Ceiling Assembly	Shows how to assemble ceiling panels and flashing.
Cover Page	Provides the product name and description, the customer name, the shipping location, and a table of contents for the Design Drawings document.  <b>NOTE</b> This is always the first page of the Design Drawings document.
Exhaust Fan and Exhaust Ductwork Assembly	Shows how to install the exhaust fan and exhaust ductwork.  <b>NOTE</b> If exhaust ductwork is not supplied by GFS, no exhaust ductwork installation drawings are provided.
Floor Assembly	Shows how to install floor panels and necessary flashing.  <b>NOTE</b> This drawing may also include wall panel assembly details.
General Arrangement (GA) Drawing	Approved submittal drawing showing the overall dimensions of the oven, oven-specific and general notes, and overall equipment operating specifications.  <b>NOTE</b> This includes miscellaneous or buyout equipment that is included with the oven but not shown in the Design Drawings.
General Structural Notes (GSN) Drawing	Provides general structural details that may pertain to the specific piece of equipment.
Internal Discharge Duct Assembly	Shows how to assemble and install duct sections inside the oven.  <b>NOTE</b> Additional drawings may be provided that show how to install additional sections of duct.
Product Door Assembly	Shows how to install the product door slabs, tadpole gasket, hardware, and flashing.
Structural Assembly	Shows how to assemble and install the oven structural frames.  <b>NOTE</b> The Structural Assembly page may also include heater box assembly details as well as door jambs and header assembly details.
Wall Assembly	Shows the order in which the insulated wall panels are assembled with the required flashing.  <b>NOTE</b> This drawing may also include heater box assembly details.

# Installation tools and equipment

## Required tools

- Screwdrivers
- Wrenches and socket set
- Standard hex key (Allen wrench) set
- Hammer and mallet
- Adjustable pliers
- Drift pins (two per person; 1/8-inch to 5/8-inch taper)
- Caulk gun
- Impact driver and drill
- Chalk and/or felt-tip marker (for marking initial measurements on floor)
- Chalk-line tool
- Laser level (*Suggested*: Quad laser or rotary laser level)
- Tape measures (35-foot and 100-foot)
- Torque nut runner
- Reciprocating saw
- Utility knife
- Wire stripper
- Welder in case modifications need to be made on site

## Recommended equipment

- Ladders
- Material handler
- Two 26-foot T scissor-lift platforms
- Appropriate lifting device(s) with a sufficient weight requirement to lift the heater box

**NOTE**

Some ovens may require higher weight and height capacities to for the end user's specific application.

- *If applicable to your oven configuration:* Extended reach forklift to set the heater box on top of the oven

**NOTE**

Lifts and cranes are not required, but they may improve both the safety and speed of installation.

**NOTE**

The end user is responsible for providing any lifts, cranes, and material handlers. Alternatively, the end user can coordinate with the installer so the installer can rent those items before starting the work.

# Installation best practices

## Unpack in stages

Organize the oven structure, heater box, duct, and panels in stages as you unpack them. In general, the skids are organized so the parts that go together during assembly are packed on the same skid.

### NOTE

For faster unpacking, use a reciprocating saw to cut the crates.

### NOTE

Other components and pieces of equipment may ship banded to skids or wrapped in plastic. Begin unpacking by cutting the plastic and bands that attach them to the skids.



**Figure 1. Skids awaiting unpacking**

A packing list is attached to each crate. As you unpack a crate, compare all the parts with that crate's packing list to check for shortages or losses in transit. Also check parts for any damage that might have been caused in shipping.

### NOTE

Slightly bent panels and angle braces can be straightened and will cause no performance or assembly problems.

**If any parts are missing or damaged**, contact Global Finishing Solutions at 800-848-8738 to speak to a Technical Service Representative.

## Follow assembly guidelines

Follow these guidelines when assembling the oven:

- Assemble the oven in stages, as described in the Design Drawings.
- Insulate between the male and female edges of the panels as they are assembled.
- Plumb the panels so that they are perpendicular to the floor. The sides of the oven must be parallel to each other.
- Use Tek screws to secure flashing.

# Installation procedure

## **DANGER**

Do not place, block, or install any objects on, in front of, or next to any explosion relief panels, ceiling panels, personnel doors, or product doors. The oven is designed to relieve pressure in case of an explosion. Ceiling panels and explosion relief side walls need a minimum of 3 feet (914 mm) and doors must be able to swing full open.

This procedure describes how to install a Batch Oven.

## **Install the oven structure**

**Reference:** Refer to the Structural Assembly page of the Design Drawings.

1. Place each column into position:

- a. Shim and grout the columns as necessary.

### **NOTE**

GFS does not provide shims or grout.

- b. Secure the columns to the floor with the anchor type suggested on the Structural Assembly drawing.

### **NOTE**

GFS does not provide the anchors.

### **NOTE**

Refer to the General Structural Notes (GSN) drawing.

2. Install the beams across the columns, working back-to-front.

### **NOTE**

**For heater boxes mounted on top of the oven:** After the beams that will support the heater box are in place, determine if you should skip ahead to the “Install the heater box” (page 26) section before completing installation of the remaining beams. If the top of the oven is accessible and lifting devices can be maneuvered into place without hindrance, proceed to Step 3.

3. Install the X-brace angles and top column angles.



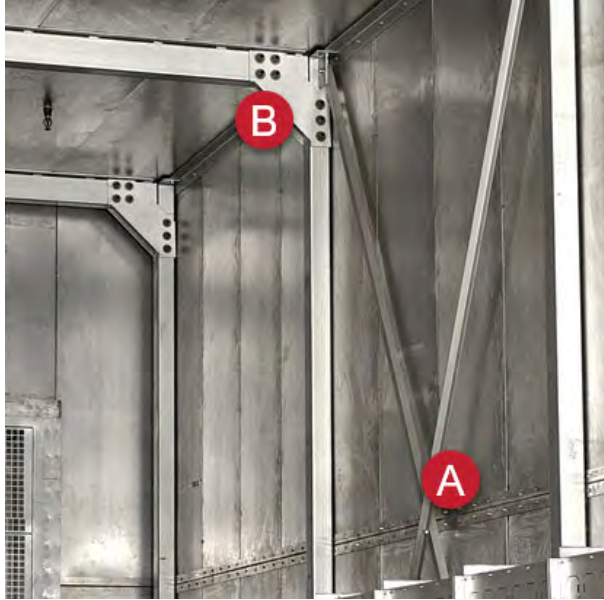

**A:** X-brace angle  
**B:** Top column angle

**Figure 2. Oven X-brace angles and top column angles**

4. Install the base channel and base corner channels around the perimeter of the oven.

**NOTE**

Temporary bracing may be required until the wall panels are installed.

5. *If applicable:* Install the door jambs and header as shown on the Structural Assembly drawing.

## Install the heater box

This section describes how to install the heater box assembly.

### NOTE

GFS heater boxes are pre-assembled and ship as an individual unit. On standard-sized heater boxes, the gas train is attached.

### NOTE

Some oven configurations require multiple heater boxes.

### NOTE

Depending on the specific configuration for this oven, the heater box(es) may be mounted on top of the oven or installed on the floor at the side or rear of the oven. Refer to the GA page of the Design Drawings to determine which configuration is specified for this oven. Then perform the appropriate task:

- **For a heater box mounted on top of the oven:** Complete the steps in “*If applicable: Install the heater box on top of the oven*” (page 26).
- **For a heater box installed on the floor next to the oven:** Complete the steps in “*If applicable: Install the heater box on the floor*” (page 26)

### ***If applicable: Install the heater box on top of the oven***

**Scope:** Perform these steps *only* if your Design Drawings show that the heater box should be installed on top of the oven.

**Prerequisites:** The columns and beams on which the heater box will be mounted must be installed and secured.

1. Use a forklift or appropriate lifting device to place the heater box into position on top of the correct structural support beams.
2. *If applicable:* Make sure that the nuts on the electric heater circuits are tight.

### NOTE

This step applies only to electric heater boxes.

### ***If applicable: Install the heater box on the floor***

**Scope:** Perform these steps *only* if your Design Drawings show that the heater box should be installed on the floor alongside the oven.

**Reference:** Refer to the Wall Assembly page of the Design Drawings.

1. Use a forklift or appropriate lifting device to place the heater box in the correct location as depicted on the Design Drawings.
2. Shim and level the heater box.

### NOTE

GFS does not provide shims.

3. *If applicable:* Make sure that the nuts on the electric heater circuits are tight.

**NOTE**

This step applies only to electric heater boxes.

## Build the end and side walls

**Reference:** Refer to the Wall Assembly page of the Design Drawings.

1. Set the insulated wall panels in place within the base channel that runs around the perimeter of the oven.

**NOTE**

Each seam must be insulated with 4-pound density strip insulation.

2. *If applicable:* Install the personnel door frame and slab.
3. *If applicable:* Install the left and right product door jambs.
4. Tek-screw the flashing and cap channel to the wall panels.
5. Tek-screw the angle iron to the wall panels.
6. Insulate any gaps around the perimeter with 4-pound density strip insulation.

## *If applicable:* Assemble the oven floor

**Reference:** Refer to the Floor Assembly page of the Design Drawings.

1. Install the floor panels inside the oven structure as described in the Design Drawings.
2. Tek-screw the flashing around the inside perimeter of the oven walls.

## Assemble the oven ceiling

**Reference:** Refer to the Ceiling Assembly page of the Design Drawings.

1. Set the insulated ceiling panels in place 1 inch from the inside of the top channel.

**NOTE**

Each seam must be insulated with 4-pound density strip insulation.

2. Tek-screw the flashing and cap channel to the ceiling panels.
3. Insulate between the ceiling panels and top cap channel with double-strip insulation.
4. Insulate any gaps around the perimeter with 4-pound density strip insulation.
5. Insulate all corners of the oven with double-strip insulation.

## Install the product door

**Prerequisites:** The wall panels must already be installed as directed in the “Build the end and side walls” (page 27) section.

**Reference:** Refer to the Product Door Assembly page of the Design Drawings. For roll-up doors, refer to the supplied manufacturer installation information.

1. Set the jamb assemblies for the product door in place.
  - a. Connect the door header assembly to the left and right door jamb assemblies for all doors.
  - b. Align and square the header and jamb assemblies.
  - c. Install the hinges and hang the product doors.
2. Attach the door handles, Brixon safety latches, and flashing.

## Install the internal discharge duct assembly

Ovens are designed with one of the following three styles of discharge ductwork:

- Ceiling mounted
- Floor mounted
- Sidewall mounted

**Reference:** Refer to the Internal Discharge Duct Assembly page of the Design Drawings to assemble your specific configuration.

1. Tek-screw the individual duct sections together.
2. *If applicable:* Use flange head bolts to install stiffeners in the duct sections.
3. Insert the sleeve of the duct into the heater box.
4. Tek-screw the duct into the heater box.
5. Bolt duct sections together.
6. *If applicable:* Install the provided duct supports.
7. *If applicable:* Install the nozzles.

### NOTE

Do not adjust the discharge duct assembly's distribution nozzles or bend tabs. This step is completed in “Adjust the internal discharge duct nozzles or bend tabs” (page 33).

## Install the exhaust fan and exhaust ductwork

**Reference:** Refer to the Exhaust Fan and Exhaust Ductwork Assembly page of the Design Drawings.

1. Position the fan in its final location and field cut a hole for the duct box into the oven panels.

**NOTE**

Use the duct box as a template.

2. Place the fan support angles and Tek-screw in place.

**NOTE**

The fan and the support angles must not span more than two ceiling panels.

3. Place the fan on the support angles and attach the duct box to the exhaust fan using the provided drawband.
4. Attach the exhaust fan discharge transition and Tek-screw in place.
5. Cut the exhaust duct to the desired length.
6. Weld the rings on the raw edges and connect the duct pieces together.  
Secure with high-temp oven caulk and the spiral bolt kits.
7. Use a no-loss stack to terminate to the atmosphere.
8. Install the airflow sensing ports.

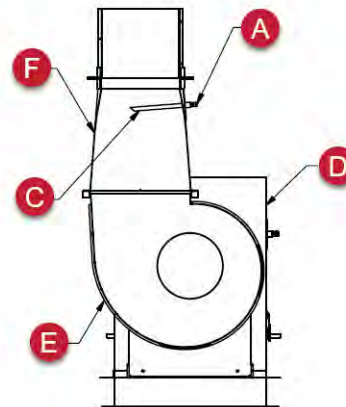
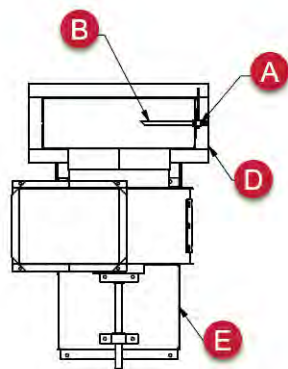

- A: Airflow sensing ports  
B: Install bevel toward the fan  
C: Install bevel down  
D: Exhaust inlet box  
E: Exhaust fan  
F: Rectangular to round transition*

**NOTE**

For instructions on connecting the 1/4-inch copper tubing from the airflow sensing ports to the airflow switch in the heater box control panel, refer to the General Oven Details.

9. *If applicable:* Insulate the exhaust duct.

**CAUTION**

Do not insulate the exhaust fan.

## Install and wire the oven control thermocouple

**Reference:** Refer to the thermocouple location(s) shown on the General Arrangement drawing.

**NOTE**

One oven temperature thermocouple must be installed and wired per heater box.

Install each thermocouple so the sensing tip protrudes into the work space and is close to the return grill of the heater box.

**NOTE**

This ensures that there is adequate airflow over the sensor.

### ***If applicable: Install the gas piping***

**Scope:** This task applies only to an oven that uses gas-fired burners. If this is an electric oven, skip this task and continue to “Install electrical wiring” (page 30).

**WARNING**

Comply with OSHA and NFPA 86 guidelines and with all applicable local electrical, safety, and fire codes and standards.

1. If multiple units are installed and served by one main gas line, determine the total volume of gas required by all units.

**NOTE**

If the supply pressure exceeds the rating of the built-in regulator, install an auxiliary high-pressure regulator in an incoming line.

**NOTE**

Refer to local codes for venting procedures.

2. Check the pressure to ensure it measures within the allowable pressure range.

**NOTE**

Refer to “Batch Oven burner settings” (page 37) for more information.

## Install electrical wiring

**Reference:** Refer to the Electrical Drawings while completing this task. For information on locating the Electrical Drawings, see “Gathering required documentation” (page 14).

**WARNING**

All wiring must conform to the latest NEC codes.

1. Refer to the oven’s rating plate for the required voltage and amperage.
2. Refer to the wiring diagram for the number of wires required for main power and remote wiring.

## Complete the Customer Pre-Startup Checklist

**Scope:** This task applies only if the site purchased the GFS factory startup service.

**Prerequisites:** The oven is fully assembled and an electrician has completed the wiring.

**NOTE**

This task is the responsibility of the customer.

**NOTE**

The Customer Pre-Startup Checklist is included with the startup documents that ship in the “Miscellaneous” box.

1. Complete the Customer Pre-Startup Checklist to verify that the oven is ready for startup.
2. Return the completed Customer Pre-Startup Checklist to GFS as directed on the form.

**NOTE**

If you purchased GFS factory startup, then upon receipt of your completed form, GFS will schedule an authorized startup technician to travel to your site to perform startup, commissioning, and training on the equipment.

# Startup tools and test equipment

This section lists tools and equipment used during the startup procedure.

## Hand tools

- 1/8-inch tip terminal screwdriver
- #2 straight-tip screwdriver
- #2 Phillips screwdriver
- 6-inch adjustable wrench
- 10-mm deep-well socket and ratchet
- Standard hex key (Allen wrench) set
- Adjustable pliers
- Wire stripper

## Test equipment

- Digital multi meter with AC and DC capabilities
- Digital manometer with 0.01-20 inch w.c. resolution
- T-joint to connect the manometer to the oven's copper piping
- 1/8-inch MPT to 1/4-inch hose barb
- 1/4-inch MPT to 1/4-inch hose barb
- 1/4-inch rubber hose

## Optional equipment

- Non-contact voltage detector
- Siemens AZL23 remote display



# Commissioning and startup procedure

This procedure describes how to commission and startup your Batch Process Oven.

## **WARNING**

Startup and commissioning must be performed by trained and qualified technicians.

**Prerequisites:** All applicable services, hookups, and other conditions specified in the Customer Pre-Startup Checklist must be ready.

## **NOTE**

Refer to your control panel operator manual to operate the oven and perform on-screen commands.

## **Adjust the internal discharge duct nozzles or bend tabs**

### **NOTE**

Regardless of the mounting style (ceiling, floor, or sidewall), distribution ductwork can take the form of bend tabs or nozzles. Both types can be adjusted to optimize the airflow into the oven. Some trial and error may be required to achieve even heat distribution.

At locations in the duct where high pressures exist, the discharge duct must be closed off more than at low-pressure locations. High pressures tend to exist in the following locations within the discharge duct assembly:

- Where air is inserted into the duct.
- At the end of a run of duct.

### ***If applicable: Bend tabs***

**Reference:** Refer to Bend Tab Configuration pages of the General Oven Details.

Open the tabs on the duct by pushing them in at least 45 degrees. Push in the tabs to direct the air into the oven.



Figure 3. Bend tabs

### ***If applicable: Nozzles***

Discharge nozzles may be located on the ductwork mounted to the ceiling and/or floor. Perform the following steps to adjust the nozzles:

1. Loosen the bolts on the nozzle.
2. Adjust the slide to allow for 50 percent open area.
3. Tighten the bolts to secure the slide in position.



Figure 4. Discharge duct nozzles

## Make sure airflow switches are plumbed correctly

**Reference:** Refer to the images below to verify that exhaust, recirculation, and combustion air switches are plumbed correctly and have not come loose during packing, shipping, or installation.

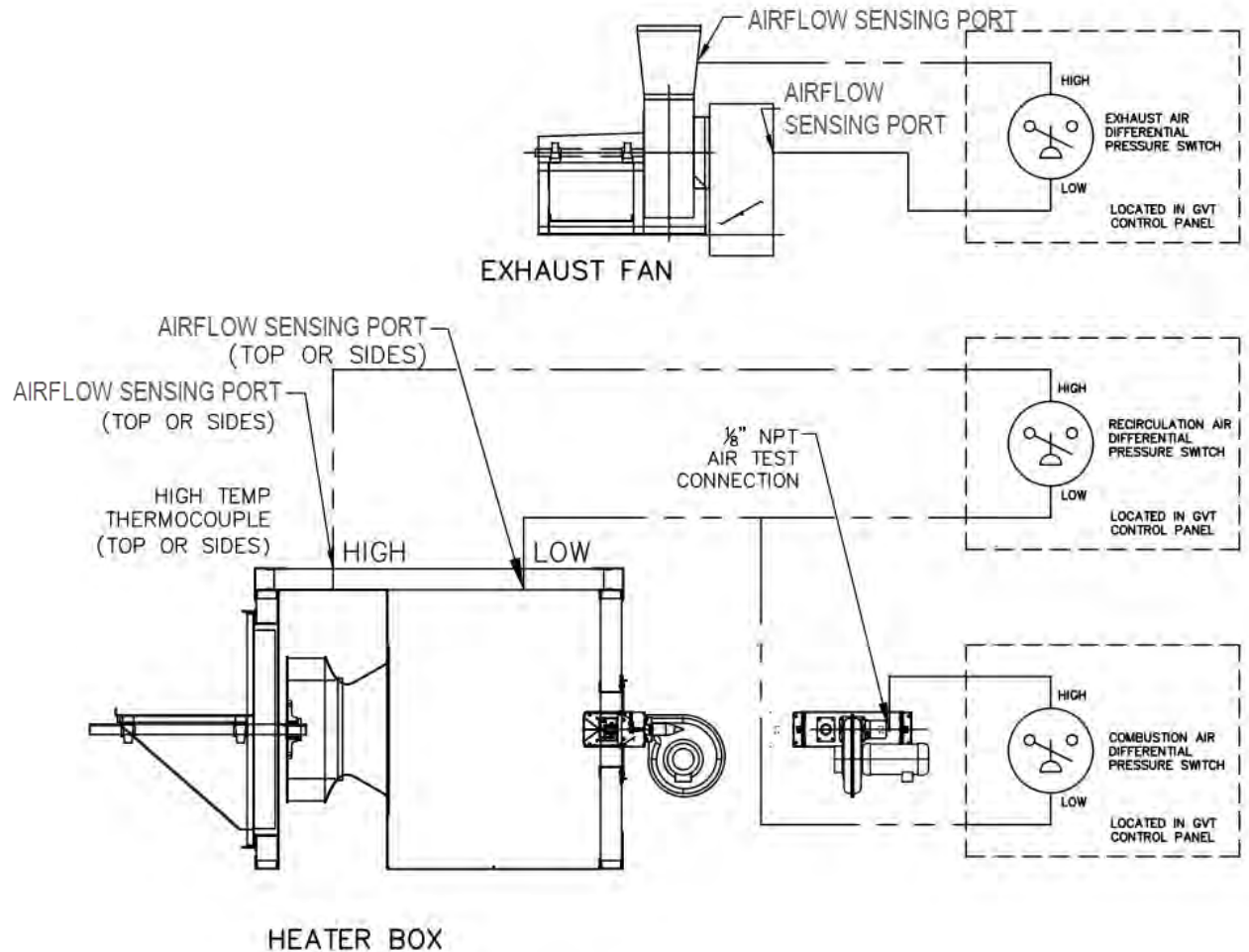

Figure 5. Illustration of high- and low-pressure lines

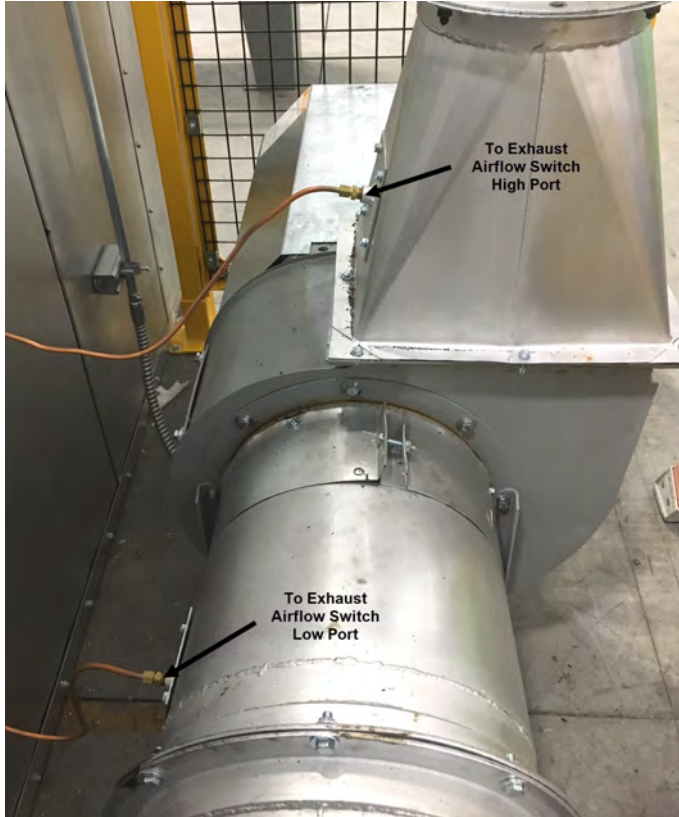

Figure 6. Exhaust airflow switch plumbing detail

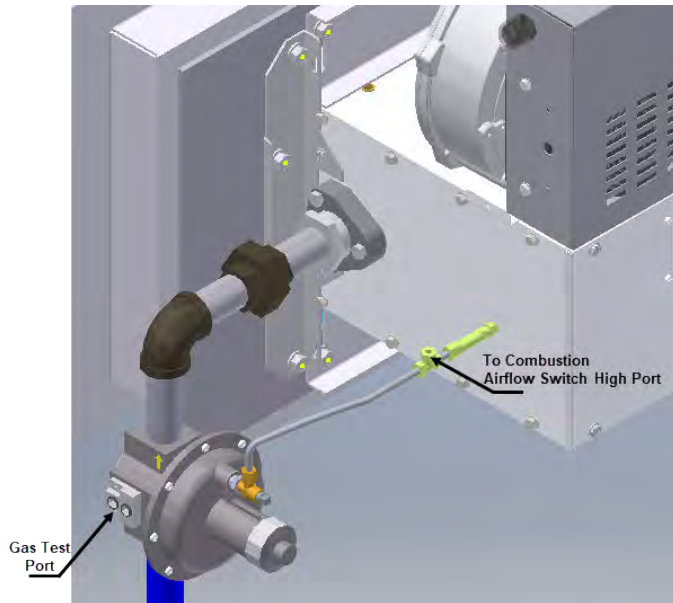

Figure 7. Combustion airflow switch plumbing detail

## Oven burner settings and gas train components

**Scope:** The procedures in this section apply only to an oven that uses gas-fired burners. If this is an electric oven, continue to “Exhaust airflow setup” (page 45).

### Batch Oven burner settings

#### NOTE

The values in Table 5 are subject to change. Refer to the burner model information table on the General Arrangement (GA) Drawing.

**Table 5. Oven operating parameters**

	Midco V1	Midco V2	Midco V3	Midco V5	Midco V7	Midco V9
<b>Maximum Input</b>	670,000	1,260,000	2,000,000	2,500,000	3,000,000	3,800,000
<b>Inlet Gas Pressure (inches w.c.)</b>	1-5 PSIG					
<b>Regulated Gas Pressure (inches w.c.)<sup>123</sup></b>	8	8	8	8	8	8
<b>Main Gas Regulator Spring</b>	BLUE					
<b>Approximate Air Supply at High Fire (SCFM)</b>	115	210	360	440	620	720
<b>Gas Pressure Differential (inches w.c.)</b>	4.5	2.9	3.4	3.8	3.9	4.4
<b>Combustion Blower Max Speed (RPM)</b>	6200	5730	5700	5700	4800	4800
<b>High Gas Pressure Switch Setting (inches w.c.)<sup>123</sup></b>	12	12	12	12	12	12
<b>Low Gas Pressure Switch Setting (inches w.c.)<sup>123</sup></b>	4	4	4	4	4	4
<b>Gas Train Inlet (inches)</b>	1	1.5	1.5	1.5	1.5	2
<b>Burner Inlet (inches)</b>	1.5					

<sup>1</sup>Approximate settings. Actual settings to be set during commissioning.

<sup>2</sup>Set the low gas pressure switch 4 inches w.c. below the actual regulated pressure.

<sup>3</sup>Set the high gas pressure switch 4 inches w.c. above the actual regulated pressure.

## Overview of gas train components

### NOTE

The devices shown in Figure 8 use a vent limiter rated for the intended service and may not require a vent line to an approved location. Please consult with your local authority having jurisdiction (AHJ):

- Main gas regulator
- Gas pressure switches

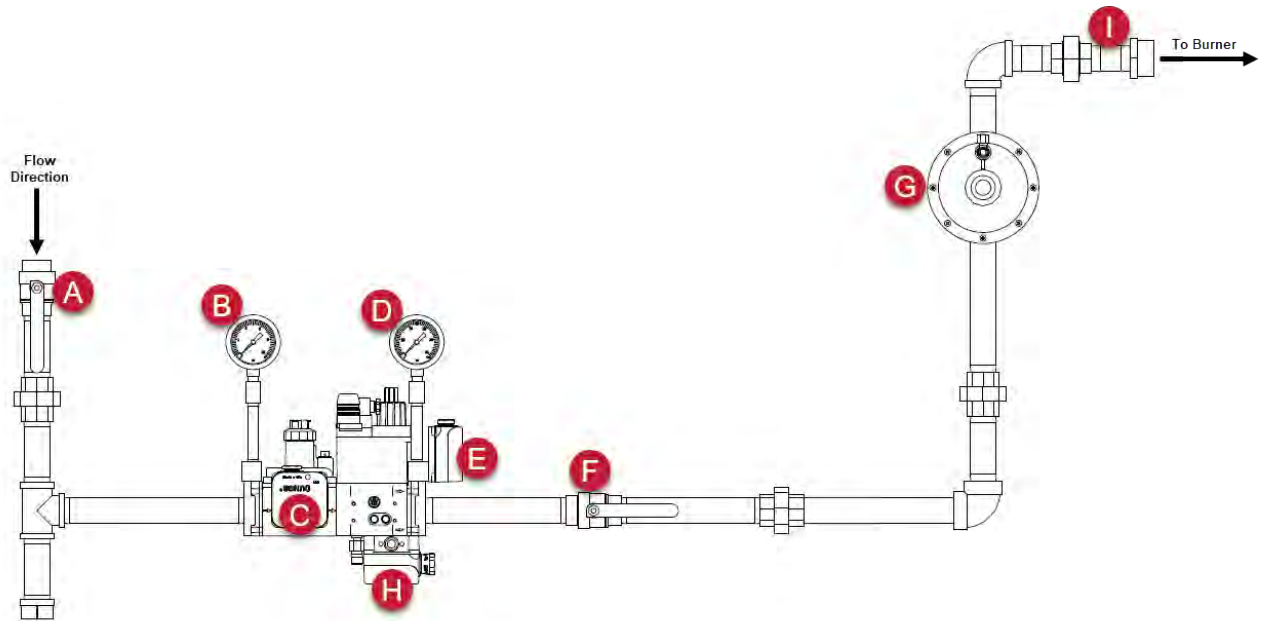

- A: Inlet manual ball valve*
- B: Inlet pressure gauge*
- C: Low gas pressure switch*
- D: Regulated pressure gauge*
- E: High gas pressure switch*
- F: Manual test ball valve*
- G: Ratio regulator*
- H: Proof of closure switch*
- I: Flow-drill port*

Figure 8. Gas train components

## Verify combustion blower air damper position

1. Confirm that the air damper is completely open and has not been moved during packing, shipping, or installation.
2. If the damper needs to be reopened, refer to Figure 9 and complete the steps below:
  - a. Loosen the bolt that secures the damper.
  - b. Pull the damper outward to open.
  - c. Retighten the bolt.



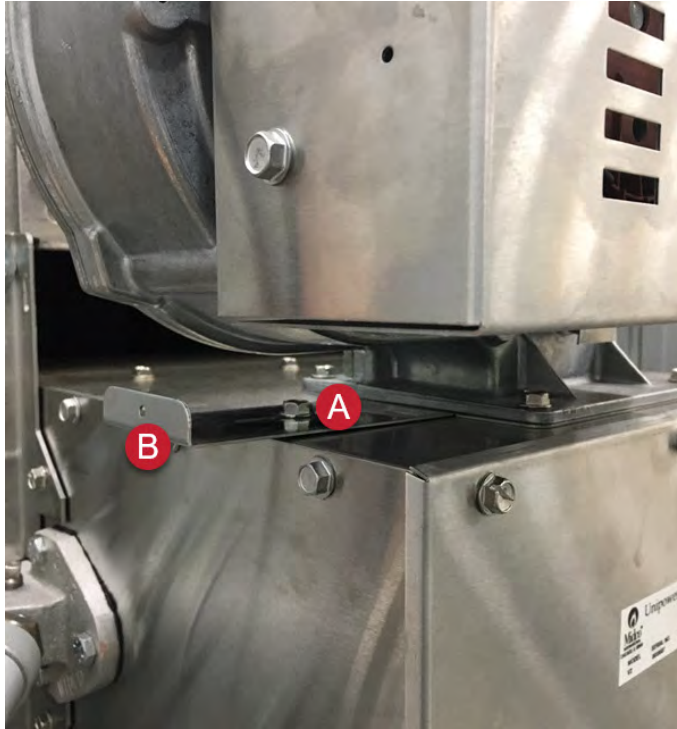

*A: Bolt that secures the damper  
B: Damper*

**Figure 9. Combustion blower air damper**

## Verify burner speed settings

Use the Siemens flame safety controller to complete the speed setting adjustment procedures in this section.

### NOTE

The flame safety controller display is built in to the control panel located on the heater box.

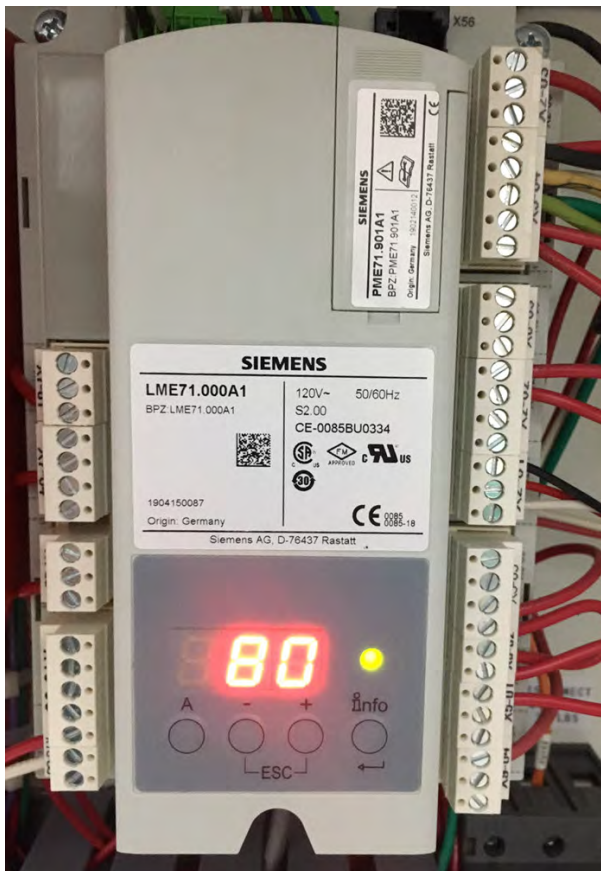

Figure 10. Siemens flame safety controller

## Verify burner ignition speed

1. Start the oven at the control panel HMI.
2. The oven will go through its normal safety checks and begin a Purge cycle. The flame safety controller displays P30 (phase 30) during this pre-ignition Purge cycle.

### NOTE

Refer to “Phase timing chart” (page 67) for full ignition and operation sequences and phase identification.

3. With 30 seconds remaining on P30, press and hold **A** and **+** on the flame safety controller for 5 seconds until the display flashes.

### NOTE

You have two minutes to complete the rest of this procedure.



4. Once the purge time is complete, the controller ignition sequence continues.
5. Prior to burner ignition, P0 will display on the flame safety controller, followed by a number.

**NOTE**

The number displayed is the ignition speed of the combustion blower, or RPMs divided by 10. Therefore, P0 . 200 means an ignition speed of 2000 RPMs.

- a. Verify that the ignition speed of the combustion blower is 2000 RPMs.
  - i. **If the ignition speed is 2000 RPMs:** Proceed to the next step.
  - ii. **If the ignition speed is not 2000 RPMs:** Press and hold **A** and **+** or **-** to increase or decrease the speed.
- b. Then press **←**.

The burner attempts to ignite. If ignition is successful, the flame safety controller will display the P1 low fire speed setting.
6. Press **←** to continue the sequence and proceed to “Verify burner high fire speed” (page 41).

**NOTE**

The burner ignition speed is now set and the flame safety controller should display the P2 value.

## Verify burner high fire speed

**Prerequisites:** The burner ignition speed must be set and the flame safety controller should display the P2 value.

**References:**

- Refer to the Table 5 to identify the max speed for the burner model used in your oven.
- The burner model is listed on the General Arrangement (GA) Drawing.

**NOTE**

Refer to the location shown in “General Arrangement (GA) drawing” (page 18).

- Refer to the gas train assembly drawing.
1. Verify that the P1 value displayed on the flame safety controller matches the speed listed in the Table 5.
  2. If necessary, press and hold **A** and press **+** or **-** to increase or decrease the value.
  3. Press **+** and **-** when complete to escape.

**NOTE**

If low fire or ignition speed adjustment is necessary, refer to “Flame safety controller appendix” (page 62) at the end of the manual.

**NOTE**

If any parameters are changed, continue to “Create a parameter backup on the flame safety controller built-in display” (page 42) to perform the backup procedure.

## Create a parameter backup on the flame safety controller built-in display

1. Press and hold **+** and **-** simultaneously for approximately one second.  
PrC will display briefly, followed by rSt.
2. Press the **+** or **-** button to toggle to bAC.
3. Press and hold the **info** button until run is displayed, then release.
4. The flame safety controller alternates between bAC and End once the parameter backup is complete.
5. Press **info** to return to the normal display.

## Set high-fire gas pressure

1. With the oven off, connect the manometer to measure the differential gas manifold pressure. Connect the + port of the manometer to the flow-drill port, downstream of the ratio regulator using a 1/4-inch NPT by 1/8-inch hose barb.

### **WARNING**

Before servicing, follow proper lockout/tagout procedures.



2. Connect the - port of the manometer to sense the low pressure side of the heater box using a T-fitting. The fitting can be located anywhere in the low-pressure line. The manometer is now set up to measure the gas pressure differential across the burner. See Figure 11 on the next page.

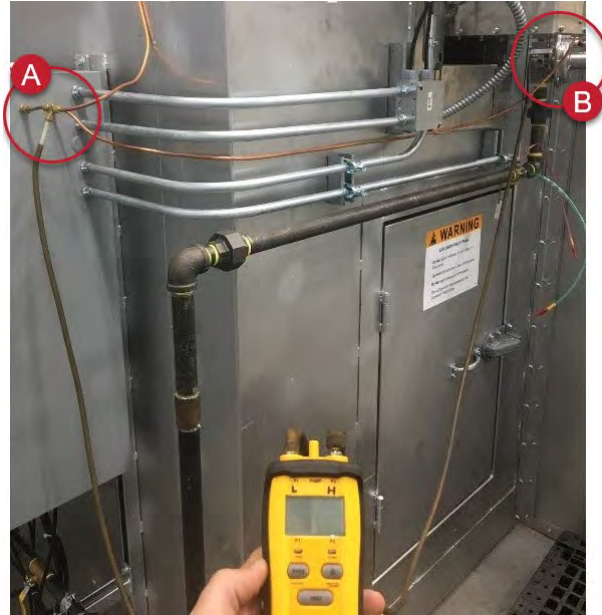

**A:** Low-pressure tap  
**B:** High-pressure tap

**Figure 11. Manometer connection points**

3. Turn on the manometer and zero it.
4. Open the manual gas shutoff valves and remove the lockout/tag-out.
5. At the control panel, start the oven.
6. With the manometer connected as described above, enable the burner on the control panel HMI.
7. Once ignited, manually force the burner to 100 percent or high fire on the flame safety controller:
  - a. Press and hold **A** until the decimal point begins to flash. This takes approximately five seconds, and  $\circ P$  will be displayed briefly, followed by the current burner output ranging from 0-100 percent.
  - b. Press and hold **A** again until  $L\circ A$  is displayed.
  - c. Continue holding **A** and simultaneously press the **+** button to increase the burner output.
  - d. When a burner output of 100 percent is reached, release the **A** button to allow the burner to modulate to that speed.
8. When the burner is operating at 100 percent, verify that the gas differential pressure reading on the manometer matches the value in “Batch Oven burner settings” (page 37) for the correct burner model. If adjustment is needed:

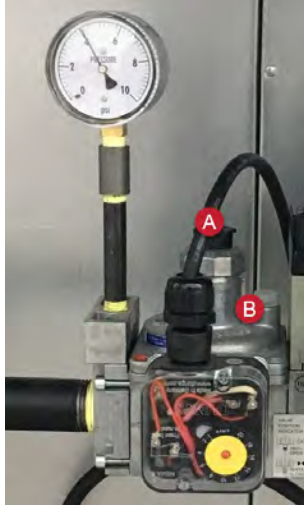

*A: Adjustment cap  
B: Main gas regulator*

**Figure 12. Main gas regulator**

- a. Remove the adjustment cap on the main gas regulator.
  - b. Use a screwdriver to increase or decrease the gas pressure until the desired differential pressure is achieved.
  - c. Replace the regulator cap.
9. Disable the burner, lock out the gas train, and remove the manometer.

**WARNING**

Be sure to remove:

- The T connection in the air line and connect the copper tube back inline with the airflow switch.
- The hose barb fitting from the flow-drill port and replace the plug fitting.

## Exhaust airflow setup

### Balance oven pressure

**IMPORTANT**

The exhaust airflow must be set properly to ensure the proper amount of fresh air is being introduced into the oven.

1. Traverse the exhaust duct when the oven is cold and record the CFM.
2. Compare the recorded value with the required exhaust CFM in the General Arrangement (GA) Drawing.

**NOTE**

Refer to the location shown in “General Arrangement (GA) drawing” (page 18).

3. Adjust the manual quadrant damper to increase or decrease airflow if necessary.

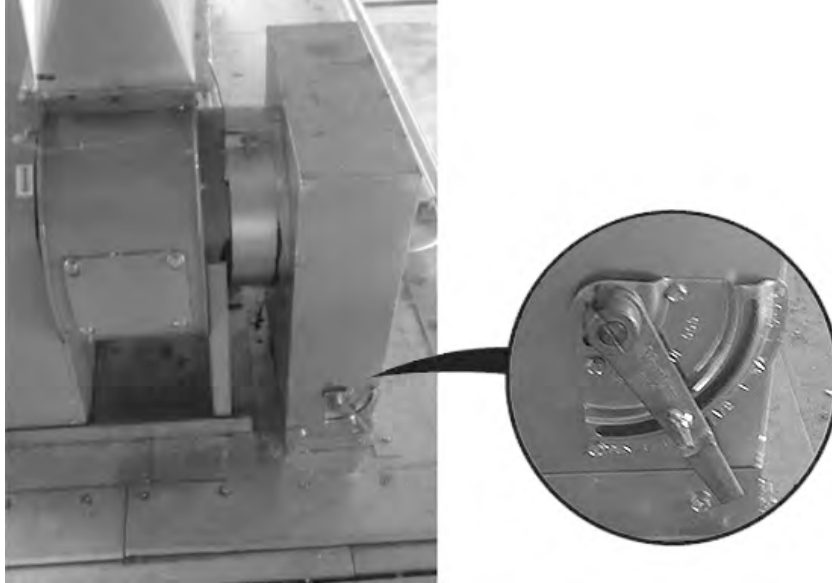

**Figure 13. Manual quadrant damper**

4. Once the recommended airflow has been achieved, lock the damper in place by tightening the wing nut on the manual quadrant damper.

## Adjust the fresh air intake

**Scope:** This step is intended to balance the oven pressure relative to the ambient surroundings. Complete “Check the air pressure” (page 46) to check the air pressure and adjust if needed.

Fresh air is introduced into the oven one of two ways:

- Via adjustable profile plates around the burner
- Through a filtered fresh air intake on the heater box

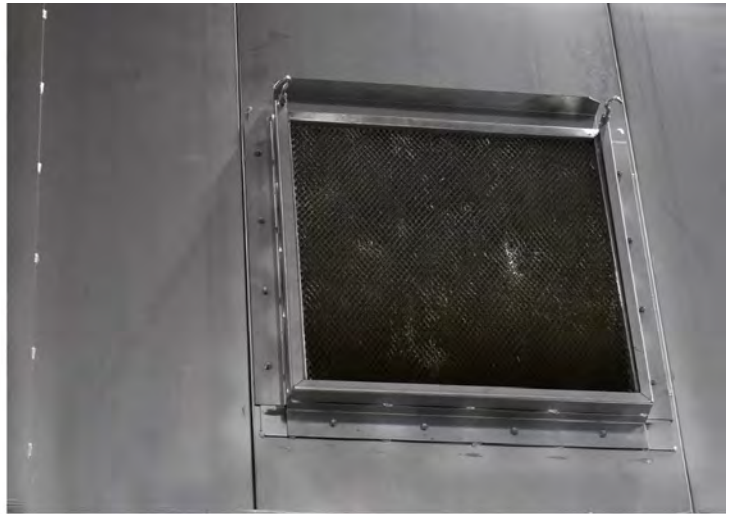
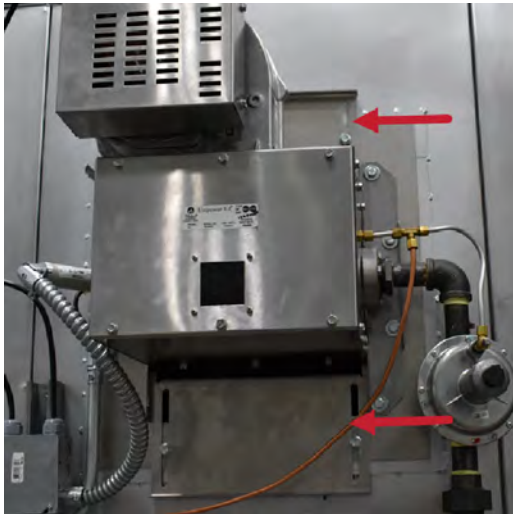

## Check the air pressure

Perform the following steps to adjust the fresh air intake:

1. Start the oven and bring it up to operating temperature.
2. Crack the product door open 1-inch.
3. Hold a sheet of tissue paper at the vertical midpoint of the door:
  - If the tissue is pulled into the oven, the oven has negative air pressure. Proceed to “Safety interlock testing procedures” (page 47).
  - If tissue is pushed away from the oven, the oven has positive air pressure.

**TIP**

The oven should operate at a slightly negative pressure.

4. If necessary, make the oven air pressure more negative by closing the profile plates or filtered intake damper.
  - a. Loosen the bolts and adjust the plates.
  - b. Tighten the bolts when a slightly negative oven pressure is achieved.

## Safety interlock testing procedures

**IMPORTANT**

Safety interlock testing procedures are required at oven startup per NFPA 86.

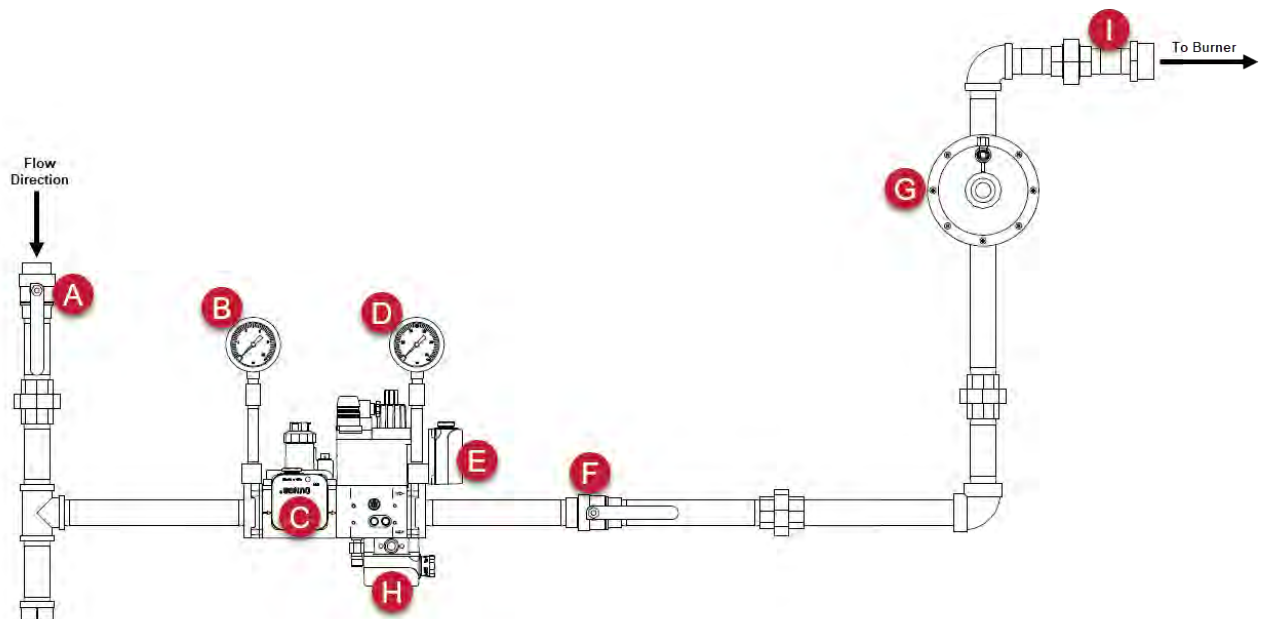

- A: Inlet manual ball valve*
- B: Inlet pressure gauge*
- C: Low gas pressure switch*
- D: Regulated pressure gauge*
- E: High gas pressure switch*
- F: Manual test ball valve*
- G: Ratio regulator*
- H: Proof of closure switch*
- I: Flow-drill port*

**Figure 14. Gas train components**

## Check the high gas pressure interlock

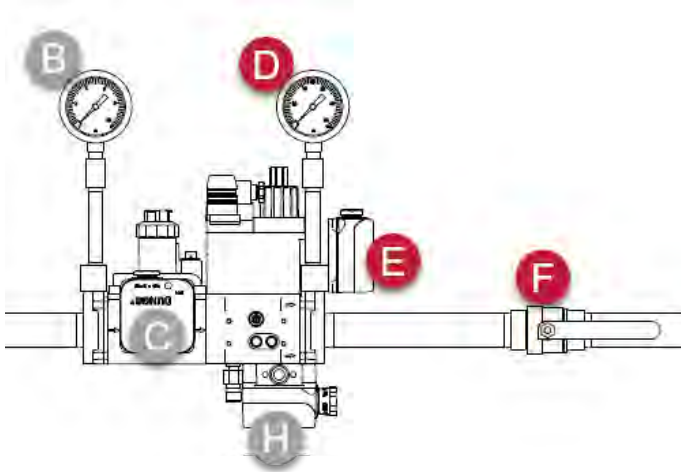

1. With the burner operating at high fire, remove the cover on the high gas pressure switch (E).
2. Adjust the setpoint using the dial on the high gas pressure switch to 4 inches w.c. above the value displayed on the regulated pressure gauge (D).
3. Slowly close the manual test ball valve (F). Observe the high gas pressure switch activation as the line pressure increase past the switch setpoint.  
An amber LED will illuminate when tripped and the burner will shut down.
4. The switch may need to be turned down to its lowest setting by hand if a flame failure occurs before the switch trips.
5. If the previous step is necessary, adjust the switch setpoint back according to step 2 after a successful test.
6. Reset the switch.



## Check the low gas pressure interlock

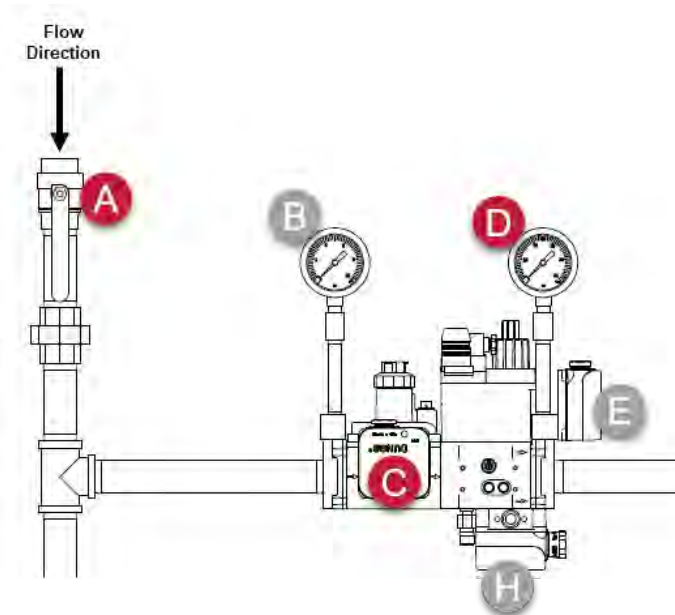

1. With the burner operating at high fire, remove the cover on the low gas pressure switch (C).
2. Adjust the setpoint using the dial on the low gas pressure switch to 4 inches w.c. below the value displayed on the regulated pressure gauge (D).
3. Close the inlet manual ball valve (A). Observe the low gas pressure switch activation as the line pressure drops.  
An amber LED will illuminate when tripped.
4. The switch may need to be turned up to its highest setting if a flame failure occurs before the switch trips.
5. If the previous step is necessary, adjust the switch setpoint back according to step 2 after a successful test.
6. Reset the switch.

## Check the flame failure interlock

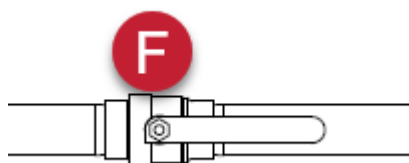

1. With the burner running, close manual test ball valve (F) between the gas train and the ratio regulator.
2. Make sure the flame safety interlock initiates a flame failure alarm and enters lockout.
3. Reset the flame safety interlock at the flame safety controller after a successful test.

**NOTE**

Refer to the “Reset faults” (page 66) for more information.

4. Open the manual test ball valve (F).

## Check the high temperature limit interlock

*If applicable:* Check the interlock on ovens with **INSIGHT** or **Proven** control panels



1. With the burner on, push and hold the **RESET** button on the high temperature limit until the **LOCK** light turns off.
2. Press the **Scroll** key in the lower left to light the **HSP1** light and display the current high temperature limit setpoint.
3. Use the **Down Arrow** to change the setpoint value to be lower than the current temperature reading of the heater box.
4. Make sure the **OP1** light is lit and the burner shuts down.
5. Set the HSP1 setpoint back to the original value and push the **RESET** button after a successful test.

*If applicable:* Check the interlock on ovens with **Converge** control panels

1. With the burner on, manually adjust the setpoint (SP) value in the Burner HTL column to be lower than the current temperature reading (PV) of the heater box.

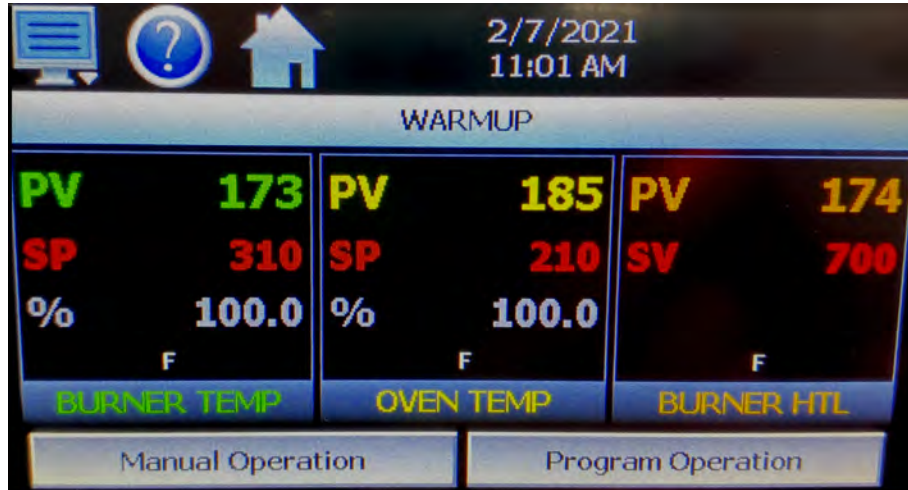

2. Make sure the alarm icon appears at the top of the screen and the burner shuts down.
3. Reset the alarm and return the setpoint to the original value.

## Check the airflow switch interlocks

**Reference:** Refer to the Electrical Drawings to identify and locate the various airflow switches.

### Check the recirculation fan airflow interlock

1. While the oven ventilation is in operation, establish the burner flame.

**NOTE**

It may be necessary to remove both the high and low pressure tubes.

2. Remove the pneumatic tubing to the recirc switch.
3. Observe the flame dropping out.

Depending on your control panel, either a fault will appear on the HMI or the ventilation indicator light will go out.

4. Reinstall the tubing in the proper location.
5. If there are multiple recirc fans, repeat this test for each switch.
6. Reset the burner safety circuit.

### Check the exhaust fan airflow interlock

1. While the oven ventilation is in operation, remove the pneumatic tubing to the exhaust switch.

**NOTE**

It may be necessary to remove both the high and low pressure tubes.

2. Observe the flame dropping out.

Depending on your control panel, either a fault will appear on the HMI or the ventilation indicator light will go out.

3. Reinstall the tubing in the proper location.
4. If there are multiple exhaust fans, repeat this test for each switch.

**NOTE**

If there are multiple heater boxes, there will be an exhaust airflow switch in each control panel.

5. Reset the burner safety circuit.

**Check the combustion airflow interlock**

1. While the oven ventilation is in operation, remove the pneumatic tubing to the combustion switch.

**NOTE**

It may be necessary to remove both the high and low pressure tubes.

2. Observe the flame dropping out.

Depending on your control panel, either a fault will appear on the HMI or the ventilation indicator light will go out.

3. Reinstall the tubing in the proper location.
4. If there are multiple combustion fans, repeat this test for each switch.

**NOTE**

If there are multiple heater boxes, there will be an exhaust airflow switch in each control panel.

5. Reset the burner safety circuit.

**Check the purge timer interlock**

1. Enable the burner.
2. Make sure the burner does not ignite until the purge time listed on the oven data plate has expired.

**Check the fire protection interlock**

1. With the oven running and the burner on, open the fire protection interlock circuit.
2. Make sure the oven shuts down.

## Safety shut-off valve leak test

1. Make sure the following criteria are met before performing the leak tests:

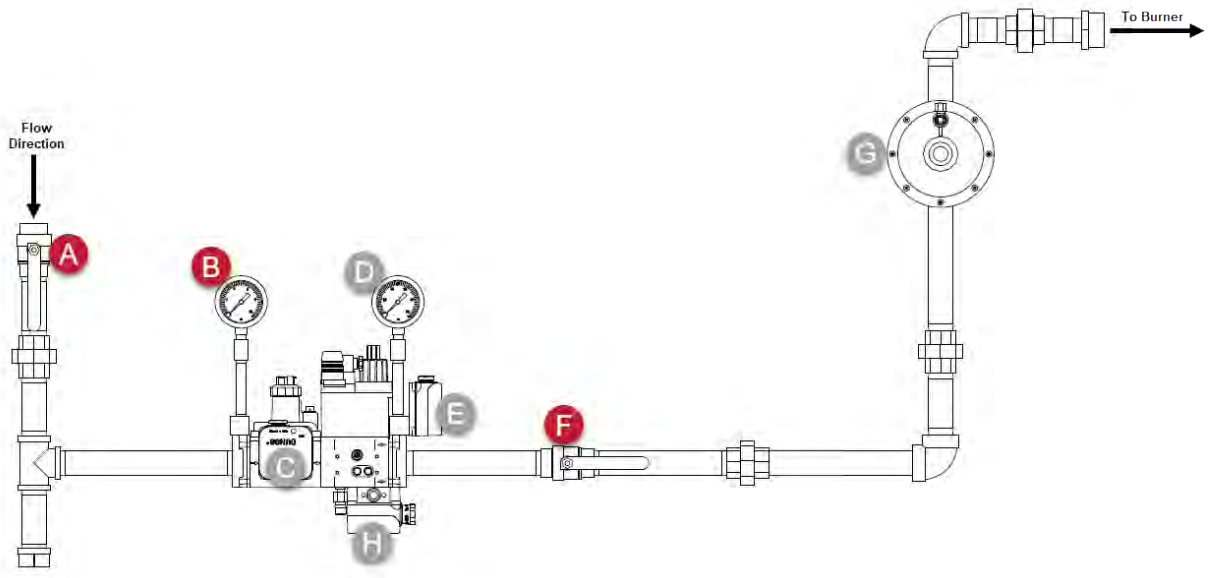

- The upstream ball valve (A) is open.
  - The downstream ball valve (F) is closed.
  - Both valves are energized.
2. Apply an all-purpose liquid leak detector solution to the "External Leakage Test Areas" shown in Figure 15 and to the following locations:

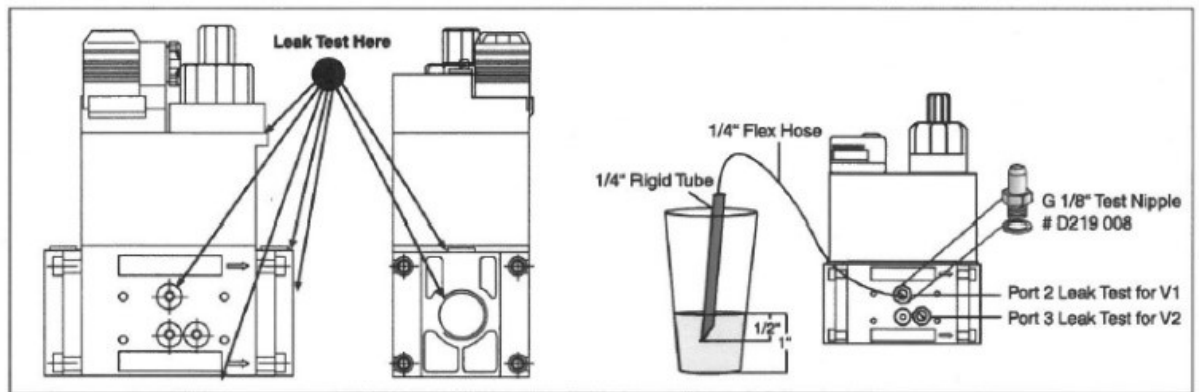

Type	Allowable Valve Seat Leakage* up to 7 PSI Inlet	# of Bubbles in 10 s		
		Air	Natural Gas	LP
DMV D(LE) 701/602	239 cc/hr	5	6	4
DMV-D(LE) 702/602	464 cc/hr	9	11	7
DMV-D(LE) 703/602	464 cc/hr	9	11	7

\*Based on air and test conditions per UL 429 Section 29. (Air or inert gas at a pressure of 1/4 psig and also at a pressure of one and one-half times maximum operating pressure differential, but not less than 1/2 psig. This test shall be applied with the valve installed in its intended position.) Volume of bubble defined in Table 2 of FCI 70-2-1998.

Figure 15. Leakage rates

- Any accessories mounted to the safety valve
- All gas piping and gas components downstream of the equipment isolation valve
- The inlet and outlet gas piping for the automatic safety shut-off valve

**NOTE**

The presence of bubbles indicates a leak. Tighten the fittings before proceeding.

3. De-energize the burner system and verify that both automatic safety shut-off valves are closed.
4. Close the upstream and downstream manual ball valves.
5. Using a screwdriver, slowly open test port 2 by turning it counterclockwise to depressurize the volume between the two valves and connect the 1/4-inch flexible hose to the test nipple.
6. Slowly open the upstream manual ball valve.

**NOTE**

Allow some time for potential leakage to charge the test chamber before measuring the valve seat leakage.

7. Immerse the 1/4-inch rubber tube vertically a 1/2 inch below the water's surface.  
If bubbles emerge from the tube after the leakage rate has stabilized, count the number of bubbles that appear within a 10 second period. See Figure 15 for allowable leakage rates.
8. Close the upstream manual ball valve.
9. Using a screwdriver, slowly open the upstream test port 3.
10. Connect test port 2 to test port 3 with a 1/4-inch flexible hose.
11. Remove the inlet pressure gauge (B) and install a 1/4-inch MPT to 1/4-inch hose barb in its place.
12. Connect a 1/4-inch flexible tube to the hose barb.
13. Slowly open the upstream manual ball valve

**NOTE**

Allow some time for potential leakage to charge the test chamber before measuring the valve seat leakage.

14. Immerse the 1/4-inch rubber tube vertically a 1/2 inch below the water's surface.  
If bubbles emerge from the tube after the leakage rate has stabilized, count the number of bubbles that appear within a 10 second period. See Figure 15 for allowable leakage rates.
15. Close the upstream manual ball valve, remove the tube between test ports, and close the test ports.
16. Reinstall the pressure gauge.

## Gas train leak test

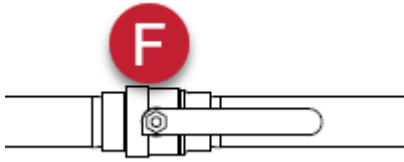

1. Make sure the following criteria are met:
  - The downstream manual test ball valve (F) is closed.
  - Both automatic safety valves are de-energized.
2. Remove the flexible hose.
3. Close all test nipples.
4. With the upstream manual ball valve open, energize oven automatic safety shut-off valves.
5. Use soapy water to leak test all nipples and confirm there are no leaks.
6. If no leakage is detected:
  - a. De-energize all automatic safety shut-off valves.
  - b. Open the downstream manual ball valve.
7. If leakage values are exceeded, replace the valve immediately.

## Complete the startup documents

**Reference:** Refer to the oven startup documents that ship in the "Miscellaneous" box.

**NOTE**

The oven startup and commissioning reports are the responsibility of the startup technician.

1. Fill in the information in the oven startup and testing reports to verify that the oven is ready for operation.

**NOTE**

For recommended tools, see "Startup tools and test equipment" (page 32).

**NOTE**

The reports can be filled in independently or in conjunction with the procedures outlined in the "Commissioning and startup procedure" (page 33).

2. *If applicable:* Return the completed startup documents to GFS as directed on the form.

**NOTE**

Inspection results shall be recorded and maintained for at least two years.

3. Notify the customer that the oven is ready for use.

**NOTE**

The customer is responsible for completing the Customer Sign-Off Form and returning it to GFS as directed on the form.



# Maintenance schedule

Items to Be Inspected and/or Cleaned	Daily	Weekly	Monthly	Yearly
Clean or replace clogged air filters.		X		
Inspect the flame sensing devices for good condition and cleanliness.			X	
Check for proper air and gas pressures.			X	
Test all system alarms for proper response signals.			X	
Check and clean the igniter electrodes.			X	
Check the valve motors and control valves for smooth action/adjustment.			X	
Ensure that the ventilation equipment is operating properly.			X	
Test the interlock sequence on all safety equipment. Manually force each interlock to fail, noting if any related equipment closes or stops as specified by the manufacturer.			X	
Test the flame safety controller by manually shutting off the gas to the burner.			X	
Ensure that the manual gas shut-off cocks are operating properly.			X	
Clean and/or replace the combustion air blower, if necessary.			X	
Inspect and clean the combustion air blower motor.			X	
Visually inspect the V-belts on the fans for wear and tightness.			X	
Lubricate fan bearings with a good general-purpose grease.			X	
Oil the door hinges and latches.			X	
Retighten the nuts on the electric heater circuits.			X	
Inspect terminal contactors and buss bars for discoloration. This is a sign of overheating, typically caused by a loose wire connection.			X	
Inspect resistive heating elements and supports for discoloration or warping (from inside the heater box). This is a sign of overheating, typically caused by a lack of airflow.			X	
Visually inspect the explosion relief vents to ensure they are unobstructed and properly labeled.				X
Test the safety shut-off valves for leaks. Valves should be tightly closed.				X
Inspect and clean the flame sensors.				X
Inspect and clean the igniter.				X
Inspect and clean the burner bodies and air wings.				X
Run the oven through the start-up and operating sequences. Ensure that the proper sequence of operation for all safety equipment is correct.				X
Clean the fan wheels to maintain proper airflow.				X
Visually check the oven and its components for wear or malfunction.				X

## Maintenance schedule

---

<b>Items to Be Inspected and/or Cleaned</b>	<b>Daily</b>	<b>Weekly</b>	<b>Monthly</b>	<b>Yearly</b>
Test the pressure switch settings by checking the switch movements against pressure settings and comparing these with the actual impulse pressure.				X
Visually check the igniter cable and connectors.				X
Clean or replace the filter screen in the KDI valve train.				X
Replace the spark plug.				X

# Troubleshooting

Use this table to troubleshoot an oven that is not operating as expected.

Symptom	Probable Cause	Remedy
<b>You cannot initiate a startup sequence.</b>	A motor overload has been tripped.	<ol style="list-style-type: none"> <li>1. Reset the motor overload switches.</li> <li>2. Check the amp draw.</li> </ol>
	An airflow switch has not made contact.	<ol style="list-style-type: none"> <li>1. Check the combustion airflow switch adjustment.</li> <li>2. Check the air filter</li> <li>3. Check the rotation of the blower.</li> <li>4. Check the outlet pressure from the blower.</li> </ol>
	An airflow switch input did not clear before attempting to restart.	<ol style="list-style-type: none"> <li>1. Allow fans to come to a complete stop.</li> <li>2. Remove airflow tubing and make sure the switch resets.</li> <li>3. Check the tubing for kinks and blockages.</li> <li>4. Replace the switch, if necessary.</li> </ol>
	The high or low gas pressure switch has activated.	<ol style="list-style-type: none"> <li>1. Check the incoming gas pressure and adjust if necessary.</li> <li>2. Reset the gas pressure switch.</li> <li>3. Check the pressure switch setting and operation.</li> </ol>
<b>The oven will not enter purge sequence.</b>	The proof of closure switch is not proven closed.	<ol style="list-style-type: none"> <li>1. Check switch operation.</li> <li>2. If the switch is operational, replace the valve.</li> </ol>
<b>The burner does not light after the purge is complete.</b>	The gas input is too high or too low for a direct spark oven.	Adjust the ignition speed (P0). Refer to "Verify burner ignition speed" (page 40) and increase or decrease the gas flow until ignition is reliable and repeatable.
	The spark is weak or non-existent.	Check that the igniter is not shorted to ground. There should be a 1/8-inch spark gap.
	The igniter is dirty.	Clean the igniter.
	There is no power to the ignition transformer.	<ol style="list-style-type: none"> <li>1. Restore the power to the ignition transformer.</li> <li>2. Verify the control circuit.</li> </ol>
	There is an open circuit between the ignition transformer and the igniter.	Repair or replace the wiring to the igniter.
<b>There is flame failure.</b>	<i>If applicable:</i> The flame rod's porcelain insulator is cracked.	Replace the flame rod.
	<i>If applicable:</i> The flame rod is grounding out.	Verify that the flame rod is installed correctly and is the correct length.
	<i>If applicable:</i> Check the lens of the UV flame detector for obstructions or a dirty lens.	<ol style="list-style-type: none"> <li>1. Remove obstructions.</li> <li>2. Clean the lens.</li> <li>3. Replace if needed.</li> </ol>
	There is not enough gas flow. (The flame will look weak or unstable when the oven is at low fire.)	Check the startup settings and adjust accordingly to increase the gas flow.
	The airflow setting is incorrect. (The flame will look weak or unstable when the oven is at low fire.)	Check the air pressure drop across the burner and adjust as necessary.

Symptom	Probable Cause	Remedy
<b>The burner does not go to high fire.</b>	There is not enough gas coming out of the main gas regulator.	Adjust the pressure regulator so that the pressure is provided as stated in "Oven burner settings and gas train components" (page 37).
	There may be clogs in the valves and regulators in the gas line. The pressure regulator may be incorrectly sized.	Check for gas pressure drop as the input is increased. Replace the pressure regulator as necessary.
	The burner gas holes are clogged.	Inspect the gas holes for dirt or lint as needed.
	<i>If applicable:</i> Optional product or personnel door switch is not in the closed position.	<ol style="list-style-type: none"> <li>1. Close the door.</li> <li>2. Check the switch is operation and replace as needed.</li> </ol>
	The flame safety controller is not receiving a full high-fire signal. <b>NOTE</b> A 20 mA signal is typical.	<ol style="list-style-type: none"> <li>1. Check the flame safety controller and linkage.</li> <li>2. Check the polarity of the signal wires. Correct as necessary.</li> <li>3. Check the output from the controllers.</li> </ol>
<b>The main flame is uneven along the length of the burner.</b>	There is poor air distribution in the ductwork.	Check the profiling and ductwork for obstructions.
	The air wings are dirty and the holes are clogged.	Inspect and clean the air wings as necessary.
<b>The main flame is yellow and over three feet long at high fire.</b>	The air wings are dirty and the holes are clogged.	Inspect and clean the air wings as necessary.
	The gas pressure is too high at the burner inlet.	Check the gas pressure against the design. Adjust the main gas pressure regulator.

# Control panel

Your oven may include a control panel that makes it easy to operate your equipment and manage your equipment's safety features and environment.

For detailed information about equipment operation, refer to the operator manual for your control panel type.

# Flame safety controller appendix

This appendix contains useful procedures and information for operating the Siemens flame safety controller using the built-in display (located in the control panel on the oven's heater box) and the optional Siemens AZL23 remote display, if purchased.

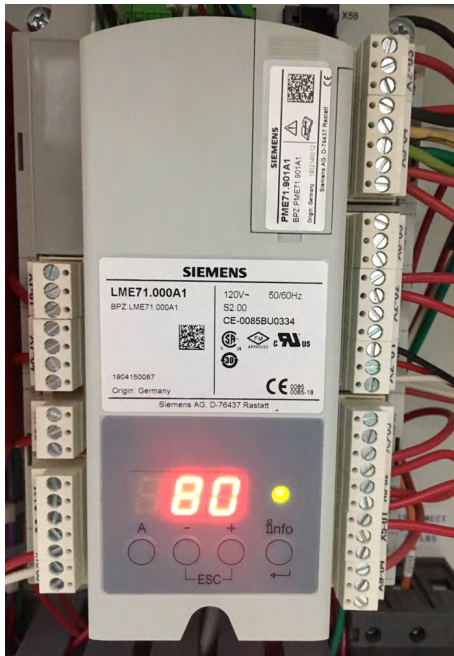

*At left: Flame safety controller built-in display  
At right: AZL23 remote display*

## Create a parameter backup

**Scope:** Perform this procedure every time a parameter is changed.

Both the Siemens flame safety controller and PME7 program module contain one parameter set. The parameter set in the flame safety controller is always used for burner operation, while the program module contains the backup.

A parameter backup automatically overwrites the PME7 program module parameter set to match the flame safety controller.

### Create a backup using the flame safety controller built-in display

1. Press and hold **+** and **-** simultaneously for approximately one second.  
PrC will display briefly, followed by rSt.
2. Press the **+** or **-** button to toggle to bAC.

3. Press and hold the **info** button until `run` is displayed, then release.
4. The flame safety controller alternates between `bAC` and `End` once the parameter backup is complete.
5. Press **info** to return to the normal display.

## Create a backup using the AZL23 remote display

1. Press and hold the **F** and **A** buttons until `Code` is displayed, then release.
2. Log in at the service or OEM level.

### NOTE

Enter `L7unI` as the password for GFS ovens.

`000: Int` will display.

3. Press the **info** button.
4. Using the **+** and **-**, toggle to parameter `060`.
5. Press the **info** button again.
6. Press **+** or **-** to toggle to `bAC_UP`, then press the **info** button.
7. Tap the **+** button twice to change the value to `1`, then press the **info** button.
8. `run` will display during the backup process.
9. The AZL23 remote display will show `bAC End` once the parameter backup is complete.
10. Press **info** to return to the normal display.

## Restore the parameters

**Scope:** Perform this procedure if a new Siemens flame safety controller is required and the PME7 program module card can be re-used. A parameter restore simplifies the replacement process by overwriting the parameters on the replacement flame safety controller with those previously saved on the PME7 program module.

Use one of the following procedures to restore the parameters:

### Parameter restore on the flame safety controller built-in display

1. Press and hold **+** and **-** simultaneously for approximately one second.  
`PrC` will display briefly, followed by `rSt`.
2. Press and hold the **info** button until `run` is displayed, then release.
3. The controller will alternate between `rSt` and `End` once the parameter restore is complete.
4. Press the **info** button to return to the normal display.

### Parameter restore on the AZL23 remote display

1. Press and hold the **F** and **A** buttons until `Code` is displayed, then release.

2. Log in at the service or OEM level.

**NOTE**

Enter `L7unI` as the password for GFS ovens.

`000: Int` will display.

3. Press the **info** button.  
`rEStorE` is displayed.
4. Press the **info** button.
5. Tap the **+** button twice to change the value to `1`, then press the **info** button.
6. `run` will display as the controller completes the restore process.
7. The AZL23 remote display will show `rSt End` once the parameter restore is finished.
8. Press **info** to return to the normal display.

## Adjust burner blower speed settings

The burner utilizes a gas/air ratio regulator, also known as a proportionator, to regulate burner output. The gas output is controlled by the air pressure of the impulse line which is plumbed to the combustion blower. The speed of the combustion blower adjusts the pressure of the impulse line.

The flame safety controller has three blower speed parameters that must be properly set for reliable ignition and operation of the burner.

**NOTE**

The parameters are set in the factory but may require field adjustment:

- `P0`: Ignition speed
- `P1`: Low fire speed
- `P2`: High fire speed

If necessary, use one of the following procedures to adjust these parameters. This can be done either with the flame safety controller or AZL23 remote display.

### Adjust speed settings with the flame safety controller built-in display

**NOTE**

Changes must be made during the burner startup sequence.

1. Start the oven at the control panel.
2. The oven will go through its normal safety checks and begin a purge cycle. The flame safety controller displays `ph30` during the pre-ignition purge phase.

**NOTE**

Refer to “Phase timing chart” (page 67) for full the ignition/operation sequence and phase identification.



3. With 30 seconds remaining on phase 30 (displayed as P. 30), press and hold **A** and **+** on the flame safety controller for 5 seconds until the display flashes.

**TIP**

You now have two minutes to complete the rest of this procedure.

4. Once the purge time is complete, the controller ignition sequence will commence.
5. At this point, the flame safety controller will alternate between displaying P0 and a three-digit number.

**NOTE**

The three-digit number is the ignition speed (P0) setpoint divided by 10. For example, if the display alternately displays P0 and 200, the ignition speed is currently set for 2000 RPM.

6. To adjust the ignition speed, press and hold the **A** button while simultaneously pressing **+** or **-** to increase or decrease the speed. The speed of the blower will change in real time. Once the desired ignition speed has been set, press the **info** button.
7. Startup continues and the burner will attempt ignition. Once the flame has been established, control will drive to the preset low fire speed (P1).
8. The flame safety controller alternates between displaying P1 and a three-digit number.
9. To adjust the low fire speed, press and hold the **A** button while simultaneously pressing **+** or **-** to increase or decrease the speed. The speed of the blower will change in real time. Once the desired low fire speed has been set, press the **info** button.
10. The burner will immediately drive to the preset high fire speed (P2).
11. The controller will alternate between displaying P2 and a three-digit number.
12. To adjust the high fire speed, press and hold the **A** button while simultaneously pressing **+** or **-** to increase or decrease the speed. The speed of the blower will change in real time. Once the desired low fire speed has been set, press the **info** button.
13. Press **+** and **-** simultaneously (escape) to return to normal operation. The PWM blower will now respond to the external load control signal being supplied to the flame safety controller.

## Adjust speed settings with the AZL23 remote display

**NOTE**

Changes must be made while the burner is disabled.

1. Log in at the service or OEM level.

**NOTE**

Enter **L7unI** as the password for GFS ovens.

2. **run** will display. Press **+** and **-** simultaneously to escape. The AZL23 remote display will then display the ignition speed (P0).
3. To adjust the ignition speed (P0), press and hold the **A** button while simultaneously pressing **+** or **-** to increase or decrease the ignition speed. Once the desired ignition speed is set, press the **+** button.
4. The low fire speed (P1) will display. Press and hold the **A** button while simultaneously pressing **+** or **-** to increase or decrease the low fire speed. Once the desired low fire speed is set, press the **+** button.

- The high fire speed (P2) will display. Press and hold the **A** button while simultaneously pressing **+** or **-** to increase or decrease the high fire speed. Once the desired high fire speed is set, press the **+** and **-** buttons simultaneously twice to return to the normal screen (OFF).

## Display the flame signal

Press and hold the **+** button on the flame safety controller.

### NOTE

The controller will briefly show `FL1`, followed by the current flame signal. This value may range from 0-100 percent.

- To briefly display the flame signal:** Hold the **+** button for **less** than three seconds. The display will return to normal upon releasing the **+** button.
- To display the flame signal for two minutes:** Hold the **+** button for **more** than three seconds. After three seconds has passed, the decimal point after flame signal value flashes.

### NOTE

To return the display to normal, either wait two minutes or press the **+** and **-** buttons together to escape.

## Access the service (Ser) menu

The service menu on the flame safety controller contains the fault history as well as the 900 series parameters that are used for diagnostic purposes.

Table 6. 900 series parameters

Value	Interpretation
954	Flame signal strength
920	Blower target speed
936	Blower actual speed

Complete the following steps to access the `Ser` menu:

- From the home screen (OFF), press and hold the **info** button until `Ser` is displayed, then release. The word `INFO` will display briefly, followed by `Ser`.
- Use **+** or **-** to navigate through the parameters in the `Ser` menu.
- When finished, press **+** and **-** simultaneously to escape.

## Reset faults

Perform one of the following steps to reset burner controller/flame safety controller faults:

- Using the flame safety controller built-in display:** Press and hold the **info** button for 1-3 seconds, then release.

**NOTE**

Pressing the **info** button for less than one second has no effect. Pressing the **info** button for more than three seconds places the controller into diagnostic mode.

- **Using the AZL23 remote display:** Press and hold the **info** button until the word rESEt appears, then release.

**NOTE**

Releasing the **info** button before rESEt appears has no effect. Holding the **info** button too long accesses the InFo menu.

## Phase timing chart

The Siemens flame safety controller can perform different burner sequences depending on which PME7 program module is used, how certain parameters are set, and how the controller is wired.

The phase diagram below illustrates when input and output terminals are expected to be energized or de-energized. A legend on the bottom of each page describes the various symbols used in the diagrams.

		LOC	OFF	21	22	24	22	30	36	38	40	42	44	OP	72	74	10
							224	225		226	257			240		234	
		STARTUP												OPERATION	SHUTDOWN		
		SAFETY TIME 1															
Terminal	Description	Notes															
INPUTS	X3-04.5	Main Voltage															
	X3-04.1	Safety Loop															
	X5-03.1	Burner On		M													
	X3-02.1	Air Pressure Switch			X		M										
	X5-01.2	Gas Pressure Switch(es)															
	X9-04.2	Valve Proving Pressure Switch															
	X10-05.2 X10-06.1/2	Flame Signal			X			X	X								
	X2-02.4	POC															
OUTPUTS	X2-02.3	POC Source	X														
	X6-03.3	Safety Valve	X														
	X2-01.3	Blower	X	X	X												X
	X4-02.3	Ignition Transformer	X	X	X	X	X	X	X	X			X	X	X	X	X
	X7-04.4	Main Valve V1	X	X	X	X	X	X	X	X						X	X
	X7-01.3	Main Valve V2	X	X	X	X	X	X	X	X						X	X
	X2-03.3	Alarm		X	X	X	X	X	X	X	X	X	X	X	X	X	X
PWM Blower Speed			S	S	S	S	T	P	P	T	I	I	I	I	O	T	P

Legend :

 Energized	 Must be energized by end of phase	 Ignition speed
 Energized or de-energized	 Standby speed	 Operation - speed determined by input signal
 De-energized	 Prepurge/postpurge speed	 Speed transitioning/modulating

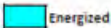
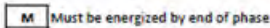
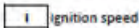
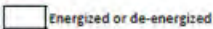
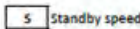
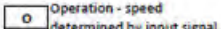
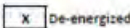
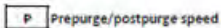
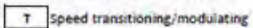
## Flame safety controller fault codes

Use this table to troubleshoot a Siemens LME7 flame safety controller that is not operating as expected.

Fault Code	Description of the Fault	Corrective Action
2	No flame at start-up	<p>A flame failure occurred during light.</p> <ol style="list-style-type: none"> <li>1. Check the wiring of the ignition transformer, pilot valve, and main valve(s).</li> <li>2. Ensure manual shutoff valves on the pilot gas line and main gas line are open.</li> <li>3. Check the fuel / air ratio at lightoff.</li> <li>4. Check the flame detector signal in the presence of a known flame source. Replace the flame detector if it does not produce the anticipated signal.</li> </ol>
3	Air pressure switch open	<p>The air pressure switch connected to terminal X3-02.1 is open, causing a fault. Ensure the setpoint of the switch is set to an appropriate value. Check the wiring of the air pressure switch. If no air pressure switch is being used, place a jumper from terminal X2-01.3 to X3-02.1.</p>
4	Extraneous light	<p>An extraneous light (flame signal present when there should be none) fault occurred.</p> <ol style="list-style-type: none"> <li>1. Ensure that the source of light is not a flame. If it is, take corrective action immediately.</li> <li>2. Ambient light can cause an extraneous light fault. Ensure the flame scanner is viewing a dark area.</li> <li>3. UV scanners typically fail on, giving a false flame signal. Remove UV scanner and cover the bulb to ensure it is not seeing any light. Look inside the bulb and see if any purple arcs of electricity are occurring between the electrodes in the bulb. If there are, replace the UV scanner.</li> </ol>
5	Air pressure switch closed	<p>The air pressure switch connected to terminal X3-02.1 is closed before the blower output is energized in phase 22, causing a fault. Ensure the setpoint of the switch is set to an appropriate value. Check the wiring of the air pressure switch. If no air pressure switch is being used, place a jumper from terminal X2-01.3 to X3-02.1.</p>
6	Actuator position fault	<p>The required position feedback from the connected SQM... actuator was not received.</p> <ol style="list-style-type: none"> <li>1. Ensure the potentiometer on the SQM... actuator is wired correctly. <ul style="list-style-type: none"> <li>-For counter-clockwise actuators (SQM40..., SQM50...), terminal "c" on the potentiometer should be wired to terminal X66.1 on the LME7, and terminal "a" on the potentiometer should be wired to terminal X66.3 on the LME7.</li> <li>-For clockwise actuators (SQM41..., SQM50...R), terminal "a" on the potentiometer should be wired to terminal X66.1 on the LME7, and terminal "c" on the potentiometer should be wired to terminal X66.3 on the LME7.</li> </ul> </li> <li>2. Ensure the SQM... actuator is wired properly to the LME7, especially the position feedback on terminal X2-09.4 of the LME7.</li> <li>3. Ensure no mechanical stops are preventing the actuator from reaching its expected position.</li> <li>4. While not common, heavy vibration on the actuator can wear a track in the position feedback potentiometer. If the fault always occurs at the same actuator position, the actuator may need to be replaced, and the vibration needs to be reduced to avoid having a similar issue with the new actuator.</li> </ol>

Fault Code	Description of the Fault	Corrective Action
7	Loss of flame	<p>A flame failure occurred during normal operation.</p> <ol style="list-style-type: none"> <li>1. Check the fuel / air ratio.</li> <li>2. Check the flame detector signal in the presence of a known flame source. Replace the flame detector if it does not produce the anticipated signal.</li> </ol>
10	Wiring or other error	<p>This fault is a catchall and can be caused by a variety of issues. See Section 7-3 for a list of all known causes of this fault. If none of the causes listed in Section 7-3 appears to be the cause, review all wiring on the LME7 and check to see if a wire is landed on an incorrect terminal.</p>
12	Fuel valve V2 leaking (PME73.840A1) Fuel valve V1 leaking (all other PME7s)	<p>On PME73.840A1, the downstream gas valve V2 failed valve proving. On all other PME7 program modules, the upstream gas valve V1 failed valve proving.</p> <ol style="list-style-type: none"> <li>1. Bubble test the gas valve to ensure the valve is not leaking. If the valve is leaking, replace the valve.</li> <li>2. Ensure that the setpoint of the valve proving pressure switch is set to 50% of the inlet pressure to the upstream gas valve.</li> </ol>
13	Fuel valve V1 leaking (PME73.840A1) Fuel valve V2 leaking (all other PME7s)	<p>On PME73.840A1, the upstream gas valve V1 failed valve proving. On all other PME7 program modules, the downstream gas valve V2 failed valve proving.</p> <ol style="list-style-type: none"> <li>1. Bubble test the gas valve to ensure the valve is not leaking. If the valve is leaking, replace the valve.</li> <li>2. Ensure that the setpoint of the valve proving pressure switch is set to 50% of the inlet pressure to the upstream gas valve.</li> </ol>
14	Proof-of-closure (POC) switch failure	<p>The POC switch is not in the expected state. If a POC switch exists, ensure it is wired to terminal X2-02.4 on the LME7. On an LME75 burner control, the source of power to the common side of the POC switch must come from terminal X2-02.3.</p> <p>If no POC switch exists, either set parameter 237 to 0 or install a jumper between terminals X2-02.3 and X2-02.4.</p>
20	Gas pressure fault	<p>One of the gas pressure switches wired to terminal X5-01.2 opened, causing a fault. It is common for both the high and low gas pressure switches to be wired to terminal X5-01.2, so the fault could be either a high gas or low gas event. Check the gas supply and open any manual shutoff valves. Check the wiring of all gas pressure switches. Check the setpoint of any gas pressure switches to ensure the setpoint is set to an appropriate value.</p>
21	High gas pressure fault	<p>The high gas pressure switch wired to terminal X2-02.4 (PME75.811A1) or X9-04.2 (PME75.812A1) opened, causing a fault. Check the wiring of the high gas pressure switch. Check the setpoint of the high gas pressure switch and ensure it is set to an appropriate value. Check pressure regulators for ruptured diaphragms or incorrect setpoints.</p>
22	Safety loop open	<p>Check all of the switches wired into the safety loop on terminal X3-04.1. One of the switches opened, causing the fault. Fix the condition that caused the switch to open and reset the fault.</p>
60	Analog input out of range	<p>The 4-20 mA input connected to terminal X65 is out of range. This input determines the position of the actuator or speed of the PWM blower. Check the wiring of the analog input. If a fault is not desired when the input drops below 4 mA, set parameter 654 to a 5.</p>

Fault Code	Description of the Fault	Corrective Action
83	PWM blower speed fault	<p>The speed of the PWM blower does not match the expected speed. More specifically, the blower speed fell outside of tolerance band 1 (parameter 650.00) for a time longer than the maximum speed deviation allowed (parameter 660), or the blower speed fell outside of tolerance band 2 (parameter 650.01). There are many possible corrective actions:</p> <ol style="list-style-type: none"> <li>1. Increase ramp time up (parameter 522) and/or ramp time down (parameter 523) to allow the blower more time to achieve the expected speed.</li> <li>2. Increase the setting of tolerance band 1 (parameter 650.00) and/or tolerance band 2 (parameter 650.01).</li> <li>3. Ensure that the maximum fan speed (parameter 519) and the number of pulses per revolution (parameter 644) are set correctly for the blower being used.</li> <li>4. Inspect wiring from PWM blower to LME7 to ensure the tachometer speed feedback signal is wired correctly.</li> </ol>
138	Restore process successful	There is no fault. This fault occurs when a parameter set was successfully restored from the PME7 program module to the LME7 base unit. Reset the fault.
139	No program module detected	This fault occurs when no PME7 program module is plugged into the LME7 base unit. Insert a PME7 program module into the LME7 base unit and reset the fault.
167	Manual lockout	A manual lockout is caused by pressing the info button and any other button, either on the LME7 base unit or on the AZL23 remote display. Reset the fault.
206	Inadmissible combination of units (LME7 / AZL23)	Reset the LME7. If the fault occurs continuously, replace the LME7 and / or AZL23.
225	PWM blower speed fault	The speed of the PWM blower dropped below the minimum prepurge speed (parameter 675.00) during prepurge, or the speed of the PWM blower exceeded the maximum ignition speed (parameter 675.01) during ignition. Adjust parameter 675.00 or 675.01, or adjust purge speed (503.01) or ignition speed (403.00).
226	PWM blower parameterization error	<p>The following parameter settings are not allowed. Correct the parameter setting that is incorrect and reset the fault.</p> <ol style="list-style-type: none"> <li>1. Speed low-fire (P1) &gt; speed high-fire (P2)</li> <li>2. Speed low-fire (P0) = 0</li> <li>3. Maximum blower speed (parameter 519) = 0</li> </ol>
227	PWM blower parameterization error	<p>One or more PWM blower settings are not compatible. Make sure the following three conditions on the minimum and maximum speed settings are met.</p> <ol style="list-style-type: none"> <li>1. 516.00 P0 516.01</li> <li>2. 517.00 P1 517.01</li> <li>3. 518.00 P2 518.01</li> </ol>
rSt Er1 rSt Er2	Incompatible PME7 and LME7	The PME7 program module and LME7 base unit being used are incompatible. PME71 program modules are only compatible with LME71 base units, PME73 program modules are only compatible with LME73 base units, and PME75 program modules are only compatible with LME75 base units.
rSt Er3	Fault during restore process	The PME7 program module was removed during the restore process. Re-install the PME7 program module and reset the fault to complete the restore process.
bAC Er3	Fault during backup process	The PME7 program module was removed during the backup process. Re-install the PME7 program module and reset the fault. Perform the backup process again.
Err PrC	No program module detected	This fault occurs when no PME7 program module is plugged into the LME7 base unit. Insert a PME7 program module into the LME7 base unit and reset the fault.