

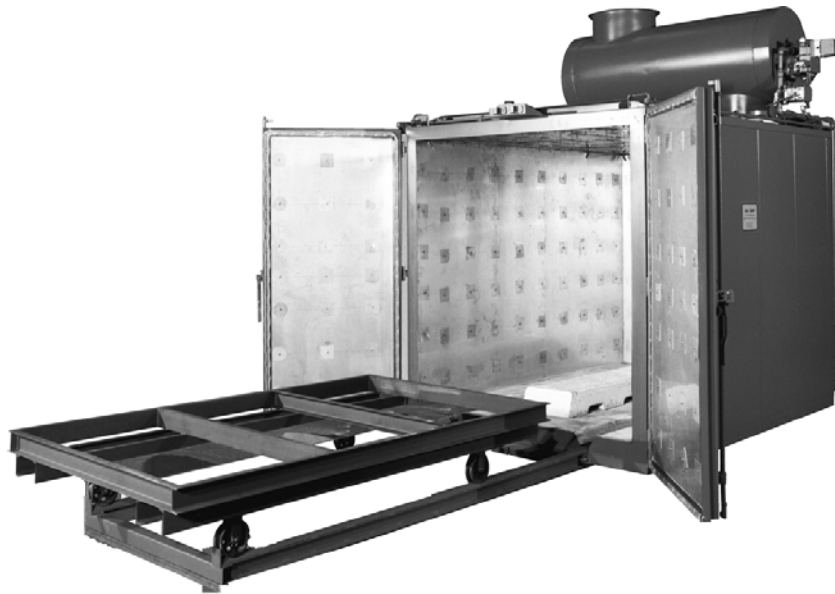

GLOBAL
FINISHING
SOLUTIONS



Batch Burn-Off Oven

Owner's Manual

Document Number: 239-079 rev 3

Publication date 4/13/2026

Read and keep this manual for future reference. All personnel operating the equipment described in this manual should review and understand all instructions before use.

Table of Contents

Introduction	3
About Global Finishing Solutions LLC	3
Contacting Global Finishing Solutions	3
Target audience	3
Conventions used in this manual	4
Safety notices	4
Information notices	4
General safety	5
Oven safety	8
Batch Burn-Off Oven description	10
Preparing for installation	11
Accepting delivery of your Batch Burn-Off Oven	11
Gathering required documentation	12
Confirming site requirements	13
Installation procedure	14
Unload the oven	14
Field install Batch Burn-Off Oven components	14
Prepare for startup	15
Oven startup	16
Safety checklist	16
Gas train components	18
Water train components	19
Startup conditions	20
Operating safeguards and interlocks	20
Loading capacities and limitations	21
First oven startup	21
Oven operation	26
Oven operation overview	26
First oven burn-off cycle	26
Normal oven cycles	28
Pause/resume profile	28
Stop/cancel profile	28
Add/modify profile	29
Maintenance schedule	34
Perform the valve leak test	36
Troubleshooting	38
Oven log sheet	40

Introduction

About Global Finishing Solutions LLC

Leading the Industry in Paint Booth and Finishing System Technology

With decades of experience, Global Finishing Solutions is the leading manufacturer of paint booths and finishing systems for many industries, including automotive refinish, aerospace and defense, industrial manufacturing, woodworking, and large equipment. By combining high-quality components, strong relationships with paint manufacturers, and our experienced distribution network, GFS provides the best equipment and support to set your business up for success.

Contacting Global Finishing Solutions

General information

- Toll-free: 800-848-8738
- Fax: 715-597-2193
- Email: info@globalfinishing.com
- Online: www.globalfinishing.com

Technical support

- Toll-free: 800-848-8738
- Fax: 715-597-8818
- Email: techservices@globalfinishing.com

Parts and filters

- Toll-free: 800-848-8738
- Fax: 888-338-4584
- Email: parts@globalfinishing.com

Target audience

This document is intended for use by trained, experienced equipment installers and maintenance technicians. If you have questions about the installation procedure described in this manual, contact GFS as described above.

Conventions used in this manual

This section describes how information is presented, organized, and referenced within this manual.

Safety notices

This manual uses the following standards to identify conditions related to safety hazards and equipment damage.

Table 1. Safety notices

Symbol	Description
DANGER	Indicates an imminent hazard that will result in death.
WARNING	Indicates a hazard that can result in serious personal injury or death.
CAUTION	Indicates a hazard that can result in personal injury.
NOTICE	Indicates a situation that can result in equipment or property damage, but poses no risk of personal injury.

Information notices

In addition to the safety notices described above, this manual uses a boldface keyword to identify certain other types of information.

Table 2. Information notices

Keyword	Description
NOTE	Denotes general information that provides additional context or guidance.
Important	Denotes information to which you should pay special attention.
Reference	Directs you to related content in a separate document.
Prerequisites	Specifies other tasks that must be completed or conditions that must exist before you perform the current task.
Scope	Describes limitations to the current task or conditions under which the task applies or does not apply to the procedure.

General safety

Follow all safety guidelines when assembling, operating, or servicing this product.

WARNING

There are inherent hazards associated with the operation and service of this equipment. For your personal safety, observe all safety information. Failure to observe these safety practices can result in personal injury or death.

WARNING

Operation and maintenance of this product must be performed properly by qualified personnel who observe the warnings in all documentation and notes provided with and on the product.

WARNING

Follow all general standards for installation and safety for work on installations. Follow all good practices for the proper use of lifting tackle and equipment. The use of protective equipment such as safety goggles and protective footwear must be considered.

WARNING

All persons who will operate, service, inspect, or otherwise handle this product must read and understand the safe operating practices, safety precautions, and warning messages in this documentation.

WARNING

The roofs of GFS equipment are not designed or intended to be walked upon or to support weight of any kind. As designed and manufactured, equipment roofs do not meet the minimum requirements of a safe walking and/or working surface under OSHA 1910.22. Under no circumstances should the roof be used by maintenance personnel or others for walking, standing, or storage of any kind. When necessary, roof access should be secured through the use of a properly supported platform that satisfies the minimum load requirements specified by ASCE 7 (Minimum Design Loads and Associated Criteria for Buildings and Other Structures) and ASCE 37 (Design Loads on Structures during Construction). Additionally, personnel should always utilize appropriate fall safety protocols when using an elevated platform. Use of the roof in a contrary manner may result in injury and/or death.

WARNING

Comply with OSHA and NFPA 86 guidelines and with all applicable local electrical, safety, and fire codes and standards.

WARNING

All ovens must comply with NFPA 86.

WARNING

All field wiring provided must comply with local codes or, in the absence of local codes, the National Electrical Code (NFPA 70).

WARNING

Electrical installation should be completed by a qualified electrician. Installation must meet all applicable national, state, and local electrical codes.

WARNING

Ensure that all electrical components are grounded to a central ground.

WARNING

Disconnect and lock out the main electrical service before installing, adjusting, or servicing the product.

WARNING

Guards and covers that prevent contact with electrically energized or moving parts are required and must not be removed or left open during operation.

WARNING

Local fire and building codes require fire protection. Check with local inspector authorities for requirements.

CAUTION

Read and save these instructions before attempting to assemble, install, operate, or maintain the product described. Protect yourself and others by observing all safety information. Failure to comply with instructions could result in personal injury and/or property damage. Retain these instructions for future reference.

CAUTION

This manual contains statements that relate to worker safety. Read this manual thoroughly and comply as directed. Operate this equipment in accordance with the guidelines set forth in this manual. It is impossible to list all potential hazards of this equipment. Instruct all personnel involved with this equipment in the safe conduct and operation of the system. GFS recommends that only qualified personnel operate and maintain this equipment.

CAUTION

Safety signs, panels, and labels that are normally affixed to the product must be replaced immediately if illegible or missing.

CAUTION

New or replacement parts that are installed during repair or maintenance must include all safety signs, panels, and labels as specified by the manufacturer. These must be affixed to the new or replacement parts as specified by the manufacturer.

CAUTION

Where applicable, use earplugs or take other safety measures for hearing protection.

NOTICE

Per NFPA 86, the product must be installed and serviced only by a trained, qualified service technician. Incorrect installation may void the warranty.

NOTICE

If you have questions about the warranty, please contact your distributor prior to contacting GFS.

Oven safety

DANGER

Ceiling panel load capacity for installation and maintenance: You must use temporary platforms that span at least two structural frames for maintenance. **Do not walk on or apply any pressure to explosion relief panels.**

DANGER

Do not place, block, or install any objects on, in front of, or next to any explosion relief panels, ceiling panels, personnel doors, or product doors. The oven is designed to relieve pressure in case of an explosion. Ceiling panels and explosion relief side walls need a minimum of 3 feet (914 mm) and doors must be able to swing full open.

WARNING

All equipment must be operated and maintained in accordance with local, state, and federal (OSHA) requirements governing occupational safety, fire protection, and oven operations. Operators must read and understand GFS and included independent equipment and/or component manufacturer's instructions prior to use. **Disclaimer:** GFS is not responsible for any injury, illness, or property damage that results from not abiding by local, state, or federal (OSHA) requirements that govern occupational safety, fire protection, and oven operations. GFS is also not responsible for any injury, illness, or property damage that is the result of not adhering to GFS and/or independent equipment/component operating, service, maintenance, and/or installation requirement's or directives.

WARNING

Install the oven in compliance with locally enforced codes and standards.

WARNING

A fire suppression system is required by the International Fire Code for class A and B ovens that contain combustible material. A fire suppression system is not supplied with this oven.

WARNING

Duct the exhaust air from the fan away from the working environment to the outdoors. Do not operate the oven unless exhaust has been ducted properly.

WARNING

Isolate the outdoor vent from air-conditioning intakes, windows, and any other equipment that may recirculate the exhaust indoors.

CAUTION

Become familiar with all controls before operating or servicing this oven.

CAUTION

Proper door alignment is critical to the operation of the oven. Ensure that there is equal space around the doors. Move the bottom of the door jamb to the left or right or in and out until the doors are sealed and plumb.

CAUTION

If this installation includes vacuum systems or monitoring equipment, install and connect those devices in accordance with the manufacturer's documentation.

CAUTION

The purchaser is responsible for advising all employees of the following cautions related to this equipment and its use:

- Burner systems that operate continuously for more than 24 hours must have an approved flame-sensing system.
- You must cool the oven to below 200 °F (45 °C) before normal shut down or handling parts.
- Part temperatures may exceed the air temperature within the oven; handle with caution.
- To avoid electrical noise interference, you must provide a separate, clean power supply for the oven's programmable controllers and/or electronic devices. If you cannot obtain such a power supply, then you must add a line conditioner to ensure proper voltage.

CAUTION

If any pumps or compressors are included as part of this equipment, they must be connected as recommended in the provided supplier documentation.

CAUTION

Guards or covers that prevent contact with electrically energized or moving parts are required to direct the flow of air for effective cooling. Never remove them or leave them open during operation.

NOTICE

GFS recommends storing crates indoors pending installation. If you must store crates outside, protect crates and their contents from moisture to prevent damage to equipment.

NOTICE

Install the control panel per NFPA 70 and local codes and standards.

NOTICE

Failure to anchor the oven to the floor properly may result in structural damage.

Batch Burn-Off Oven description

The Batch Burn-Off Oven is designed to remove a limited amount of fully cured paint, powder coatings, epoxies, lacquers, urethanes, and other organic or inorganic compounds from metal parts. To do this, fixtures are slowly heated from 300 °F (149 °C) to 750 °F (398 °C) without direct flame impingement. The combustible cured coating is reduced to smoke and ashes. Water vapor and air are discharged into the atmosphere.

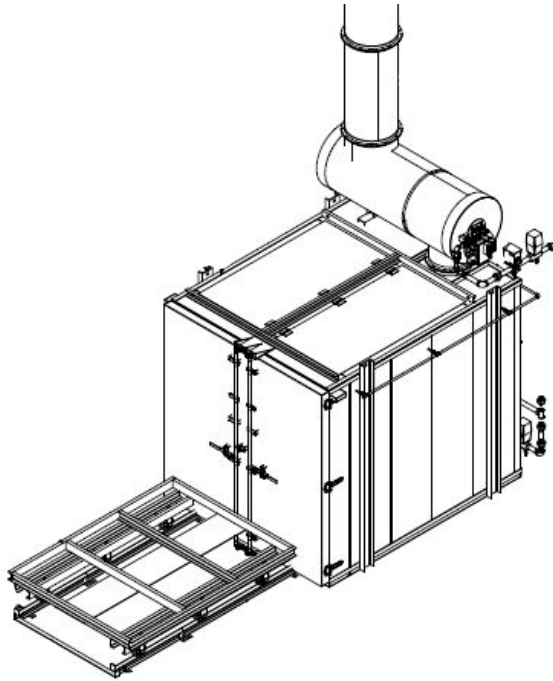

IMPORTANT

This unit is not designed for rapid coating burn-off of uncured coatings.

Preparing for installation

Accepting delivery of your Batch Burn-Off Oven

A Batch Burn-Off Oven is delivered by trailer as a pre-assembled unit. The cart, track, exhaust stack, and afterburner are shipped loose for field assembly.

Upon delivery, inspect the Batch Burn-Off Oven for any signs of damage.

NOTE

If you see shipping damage, note it on the freight carrier's paperwork; failure to do so may result in claim denial.

If the Batch Burn-Off Oven is damaged, contact Global Finishing Solutions at 800-848-8738 to speak to a Technical Service Representative.

NOTICE

GFS recommends storing crates indoors pending installation. If you must store crates outside, protect crates and their contents from moisture to prevent damage to equipment.

Gathering required documentation

Table 3 lists the location of the hard-copy documents that ship with the oven. Ensure that you can locate these documents and that they are available during the installation procedure.

NOTE

Certain manuals, project drawings, and the Job-Specific Guide are also provided electronically to distributors via box.com. Many manuals are available for download on globalfinishing.com.

Table 3. Additional documentation

Document	Description	How provided
Design Drawings	Provides detailed drawings and instructions for assembling this particular oven	Ships in the "Miscellaneous" box
Electrical Drawings	Provides wiring diagrams for electrical components	Ships inside the control panel

Confirming site requirements

Before beginning the installation procedure, confirm that the site where the equipment will be assembled meets the following requirements:

- The floor where you will assemble the oven is level.
- The area is large enough to allow a minimum of 3 feet (914 mm) of clear space on all four sides of the oven. Some exceptions may apply. Check local codes and refer to NFPA guidelines to determine particular space allowances.
- There is sufficient overhead clearance for the exhaust ductwork in the area where the equipment is to be located.
- Do not alter or otherwise restrict combustion or exhaust openings.
- Vent the exhaust outside the building.
- There must be adequate structural support and minimal exposure to power equipment, process equipment, and sprinkler risers.
- The area where you will assemble the oven is free of any corrosive or explosive vapors, such as chlorinated vapors, acid vapors, or volatile solvents.
- The facility in which the oven will be installed must have adequate gas flow and pressure to operate the oven at full burner output. (The gas specification is included with the submittal or provided at delivery.)
- A licensed electrician has verified that the incoming power meets the requirements specified for the equipment. (The power specification is included with the submittal or provided at delivery.)
- The appropriate devices for lifting/rigging are available onsite.

Installation procedure

DANGER

Do not place, block, or install any objects on, in front of, or next to any explosion relief panels, ceiling panels, personnel doors, or product doors. The oven is designed to relieve pressure in case of an explosion. Ceiling panels and explosion relief side walls need a minimum of 3 feet (914 mm) and doors must be able to swing full open.

This procedure describes how to install a Batch Burn-off Oven.

Unload the oven

NOTE

The Batch Burn-Off Oven is delivered by trailer as a pre-assembled unit.

NOTE

Lifting lugs are provided to lift the Batch Burn-Off Oven off of the truck and position it in the desired location.

1. Lift and move the oven to its desired location.
2. Unbolt the lifting lugs.
3. Bolt the four-corner hold down points to the concrete slab with expansion anchors.

CAUTION

Please consult Global Finishing Solutions at (800) 848-8738 to speak to a Technical Services Representative if you have questions regarding the loading or unloading of the oven. Structural damage caused by improper lifting may result in costly and time-consuming repairs.

Field install Batch Burn-Off Oven components

Reference: Refer to the Design Drawings.

1. Install the track extensions.
2. Assemble the part cart.
3. Install the afterburner
4. Install the exhaust stack and flashing are in place. It is the customer's responsibility to support the stack.

NOTE

GFS does not supply the supports.

Prepare for startup

NOTE

Refer to the Design Drawings to locate the utility requirements for the oven.

Perform the following steps prior to oven startup:

1. Run a water line to the unit and ensure the line has the appropriate pressure and no leaks.
2. Run electricity to the unit and make sure it is supplied with the correct voltage.
3. Run a gas line to the unit and ensure the line has the appropriate pressure and no leaks.

NOTE

The gas company will determine the size of the gas line.

Oven startup

Safety checklist

Reference: Refer to the diagrams in “Gas train components” (page 18) while completing this procedure.

Before starting this Batch Burn-Off Oven for the first time, use the following chart to make sure the factory settings are correct and that all safety switches function properly.

Device	Setup and Test Procedures
Check the high gas pressure interlock	<ol style="list-style-type: none"> 1. With the flame established, remove the cover on the high gas pressure switch. 2. Adjust the setpoint using the dial on the high gas pressure switch to 14 inches w.c. above the value displayed on the regulated pressure gauge. 3. Slowly close the manual test ball valve (L). Observe the high gas pressure switch activation as the line pressure increase past the switch setpoint. 4. The switch may need to be turned down to its lowest setting by hand if a flame failure occurs before the switch trips. 5. If the previous step is necessary, adjust the switch setpoint back according to step 2 after a successful test. 6. Reset the switch.
Check the low gas pressure interlock	<ol style="list-style-type: none"> 1. With the flame established, remove the cover on the low gas pressure switch. 2. Adjust the setpoint using the dial on the low gas pressure switch to 3 inches w.c. below the value displayed on the regulated pressure gauge. 3. Close the inlet manual ball valve. Observe the low gas pressure switch activation as the line pressure drops. 4. The switch may need to be turned up to its highest setting if a flame failure occurs before the switch trips. 5. If the previous step is necessary, adjust the switch setpoint back according to step 2 after a successful test. 6. Reset the switch.
<p>If applicable: Combustion Air Proving Switch</p> <p>NOTE This procedure applies only to Batch Burn-Off Ovens using Midco J121A-3 burner models.</p>	<ol style="list-style-type: none"> 1. Establish the main flame. 2. Remove the pneumatic tubing to the combustion switch. <p>NOTE It may be necessary to remove both the high and low pressure tubes.</p> <ol style="list-style-type: none"> 3. Observe the flame dropping out. 4. Reinstall the tubing in the proper location. 5. If there are multiple burners, repeat this process for each airflow switch. 6. Reset the burner safety circuit.
Safety Shut-Off Valves	Refer to the procedure in “Perform the valve leak test” (page 36).

Device	Setup and Test Procedures
Flame Rod	<ol style="list-style-type: none"> 1. Establish the main flame. 2. Slowly close the manual gas cock downstream of the second safety shut-off valve. 3. When the gas runs out, the flame will go out and the flame relay indicates a flame failure. 4. Open the manual gas cock. 5. Establish flame and record the signal. 6. Allow the system to operate through at least one startup sequence to make sure all components are functioning properly.
Door Limit Switch	<ol style="list-style-type: none"> 1. Close the doors. 2. Attempt startup. 3. The burner should not light. 4. Allow the system to operate through at least one startup sequence to make sure all components are functioning properly.
Oven High Temp Limit Switch	<ol style="list-style-type: none"> 1. Establish main flame and allow equipment to achieve an operating temperature of 200 °F (43 °C). 2. Set the high limit cut-off point to 180 °F (82 °C). 3. The alarm should sound and the oven burner should shut down. 4. Silence the alarm. 5. Reset the high limit to the specified setting. 6. Allow the system to operate through at least one startup sequence to make sure all components are functioning properly.
Afterburner High Temp Limit Switch	<ol style="list-style-type: none"> 1. Establish main flame and allow equipment to achieve an operating temperature of 200 °F (43 °C). 2. Set the high limit cut-off point to 180 °F (82 °C). 3. The alarm should sound and the afterburner should shut down. 4. Silence the alarm. 5. Reset the high limit to the specified setting. 6. Allow the system to operate through at least one startup sequence to make sure all components are functioning properly.
Water Pressure Safety Switch	<ol style="list-style-type: none"> 1. Increase the setpoint above the actual water pressure. 2. The Safety Switches On light should be off. 3. Return the setpoint to 20 psi. 4. Make sure the Safety Switches On light is illuminated.
<p>If applicable: Water Pressure Regulator</p> <p>NOTE This applies only to ovens with primary and secondary water suppression.</p>	<p>Set the regulator at half of the inlet water pressure provided by your facility</p> <p>TIP If the plant pressure is 40 psi, set the regulator at 20 psi.</p> <p>NOTE The water pressure regulator is located below the primary solenoid valve.</p>
Emergency Stop	<ol style="list-style-type: none"> 1. Establish the main flame. 2. Press the Emergency Stop button. 3. The alarm should sound and the burner should shut down. 4. Silence the alarm. 5. Allow the system to operate through at least one startup sequence to make sure all components are functioning properly.

Gas train components

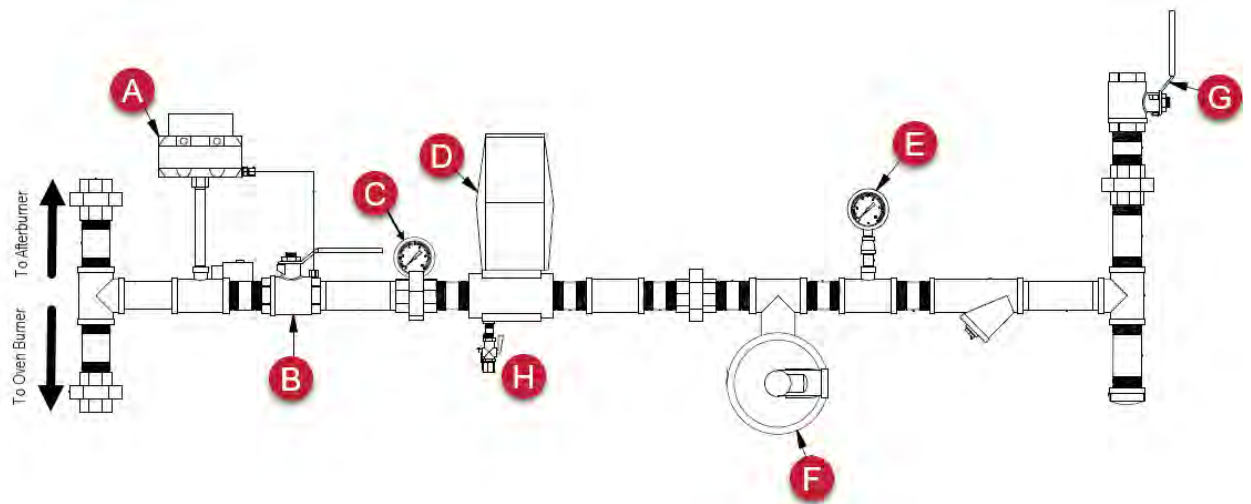

- A: High/low gas pressure switch*
- B: Shut-off valve*
- C: Regulator gas pressure gauge*
- D: Safety shut-off valve 1*
- E: Inlet gas pressure gauge*
- F: Gas pressure regulator*
- G: Shut-off valve (lockable)*
- H: Valve 1 test port*

Figure 1. Batch Burn-Off Oven primary gas train components

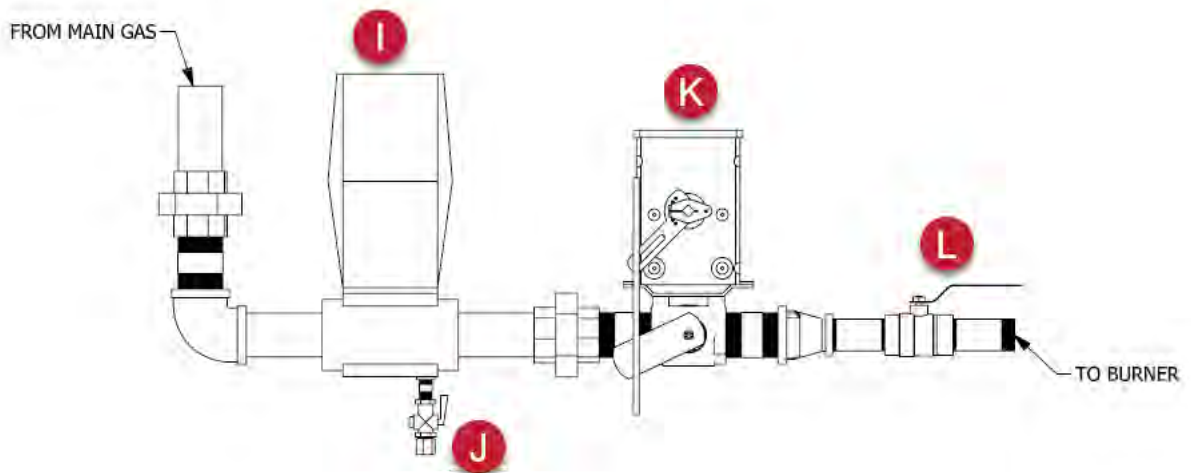

- I: Safety shut-off valve 2*
- J: Valve 2 test port*
- K: Modulating control valve*
- L: Manual test ball valve*

Figure 2. Batch Burn-Off Oven secondary gas train components

Water train components

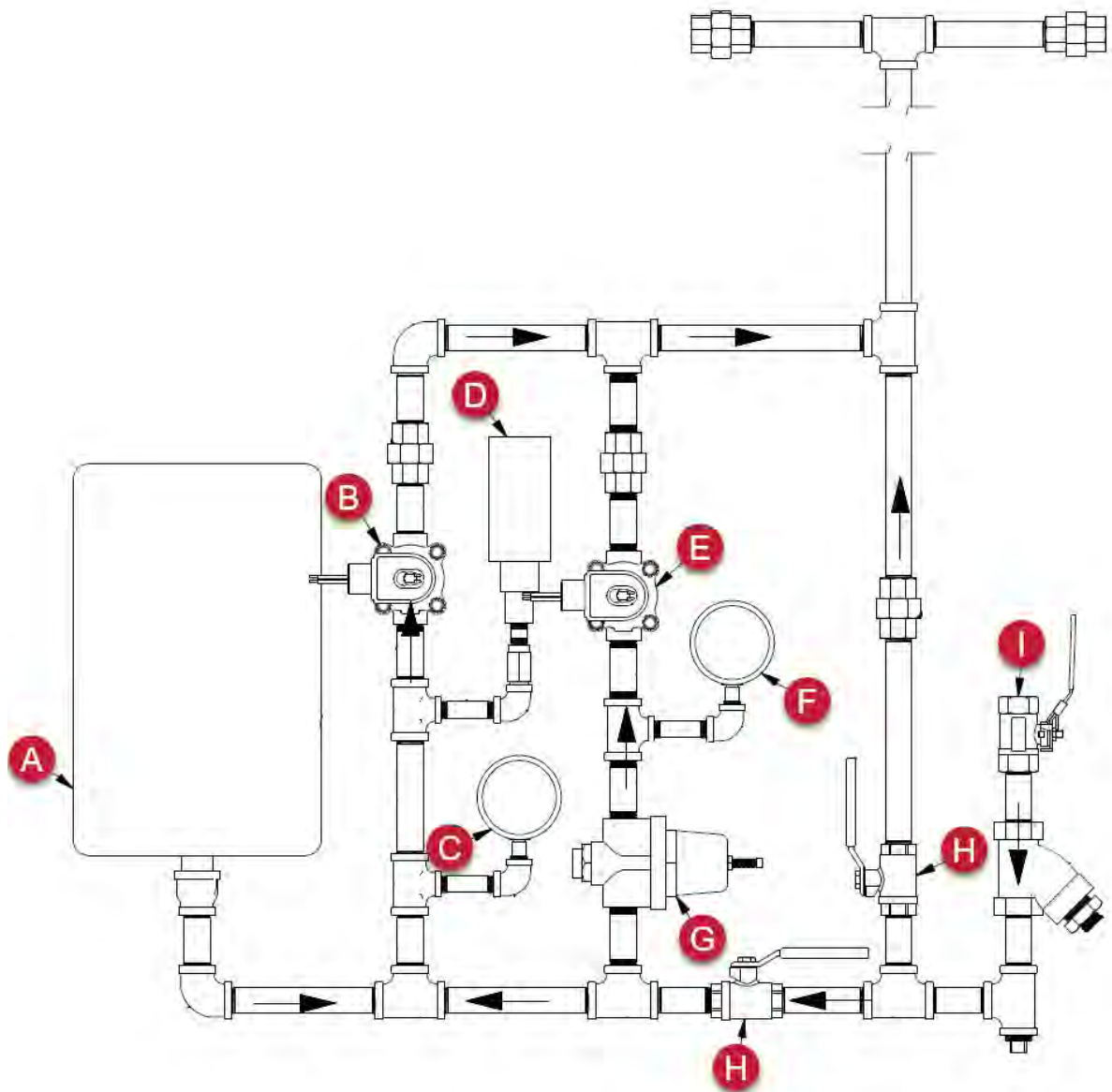

- A: Water pressure tank*
- B: Secondary spray solenoid valve*
- C: Primary spray pressure gauge*
- D: Pressure switch*
- E: Two-way solenoid valve*
- F: Secondary spray pressure gauge*
- G: Water pressure regulator*
- H: Test/emergency spray valve (close during normal operation)*
- I: Shut-off valve*

Figure 3. Batch Burn-Off Oven water train components

Startup conditions

The following conditions must be met before operating this Batch Burn-Off Oven:

- All personnel using this equipment have read and understand this manual.
- The oven has been loaded properly.

NOTE

The oven should not be loaded for initial startup. See “First oven startup” (page 21) for more information.

- Cart extension tracks have been moved out of the way.
- The burner tube and end cap have been installed correctly.

Make sure the tube is centered with the cut-out in the back wall where the burner is positioned.

- Power is available to the control panel and the Alarm Silenced light is on.
- The cooling water hand valve is open and the pressure switch is activated.
- The hand valve for the main gas is open and the gas pressure switches have been reset.
- The door is open, the door limit switch is activated, and the Door Open light is illuminated.
- The Safety Switches On light is illuminated.
- The main gas valve is closed.

NOTE (On initial start from standby for the requirement of pre-purging the oven)

The door(s) to the oven are proven open and in contact with the door(s) open proving limit switch(es). Depress the Start System pushbutton. The pilot light indicating Door(s) Open remains on, System in Purge mode is illuminated. A 60-second purge of the main oven chamber will take place. The main pilot and main gas valve will open. With the safety loop devices in place, each burner flame relay will begin its start sequence. Upon completion of a purge time, the burner(s) will go into preignition and burner on. With both burners proving ignition is complete and operating, the purge complete pilot light will indicate purge is complete and the product door(s) can now be closed.

Operating safeguards and interlocks

Should a pressure switch open or a flame failure occur, you will not be able to relight the burners until you fix the malfunction and reopen the oven door for a safe condition and normal startup. The gas will shut off if any of the following safeguards or interlocks open during operation:

- Excess oven temperature

NOTE

An alarm will sound to alert the operator of this condition. Silence the horn, allow time for the oven/afterburner to drop back below the setpoint temperature, then press reset on the excess temperature controller to relight the burner. You do not need to reopen the oven door to continue the cycle.

- Excess afterburner temperature

NOTE

An alarm will sound to alert the operator of this condition.

- Minimum afterburner temperature interlock

NOTE

The oven temperature will not be allowed to increase above 300 °F unless the afterburner temperature is at or above 1200 °F.

- Afterburner flame safeguard
- Low gas pressure switch
- High gas pressure switch
- Low water pressure switch
- Oven flame failure

Loading capacities and limitations

WARNING

Ignition of the oven burners may cause an explosion.

CAUTION

Do not process paint or paint sludge, paint filters, PVC, lead, rubber-coated scrap wire, oil, wood, grease, trash, or magnesium. Do not burn coatings that may contain chlorine (PVC), fluorine (Teflon), or elements other than carbon, hydrogen, and oxygen, as they will form toxic and corrosive products.

NOTE

Burn-off ovens have no forced air exhaust, so solvent fumes could fill the oven interior and the room surrounding the oven.

- Parts must fit inside the cart that is furnished with the oven. The cart is designed specifically to maximize the airflow around the part, and any modifications to the cart may negatively affect the oven's performance.
- Make sure that the hook and rack configurations do not allow the parts to be nested or stacked so they touch each other over an appreciable area. This causes inadequate airflow and may hinder the decomposition of the combustible material.
- Only burn off cured paint and coatings. Never burn off dip racks, paint booth gratings, or parts that have not gone through a cure oven to evaporate the solvents in uncured paint.

First oven startup

Perform the steps below with an empty Batch Burn-Off Oven.

NOTE

The first segment of the startup is done to fully cure the refractory floor. It takes approximately 22 hours to run the initial startup profile.

1. With utility connections and power supplied to the unit, turn power on and make sure the Safety Switches On light is illuminated, indicating that the gas and water pressure safety switches are made.
2. Prior to starting the initial fire segment, open the oven door, and verify the Door Open and System Purging lights are illuminated.
3. After approximately one minute, verify that the System Purging light goes out, and the Purge Complete light illuminates.
4. Close the oven door and verify the Door Open light is not lit.
5. At the Oven Temperature Controller, select the initial floor curing profile **P9.00**:

- a. Press the ▲▼ buttons at the same time to reset the controls.



- b. Press the [Reset] button to display the current profile and segment number. The first segment is typically P_.00.



- c. Use the ▲▼ buttons to select the desired profile: P9.00.
- d. Press the [Mode] button to access the Mode display. Use ▲▼ to select Run mode.



- e. Press and hold  for 5 seconds, until the Run light is illuminated and the unit starts.
6. The Batch Burn-Off Oven takes 4 hours to ramp up to 300 °F and will hold that temperature for 3 hours. Use this time to verify that the main burner gas pressure is set to 6 inches w.c. on the pilot line pressure gauge. If needed, adjust the pressure:
 - a. Locate the main gas regulator and remove the regulator cap.



- i. To increase pressure, turn the adjustment spring cap clockwise a half turn at a time.
 - ii. To decrease pressure, turn the adjustment spring cap counter-clockwise a half turn at a time.
 - b. Monitor the gas pressure at the pilot line pressure gauge. Repeat the steps above until a pressure of 6 inches w.c. is reached.

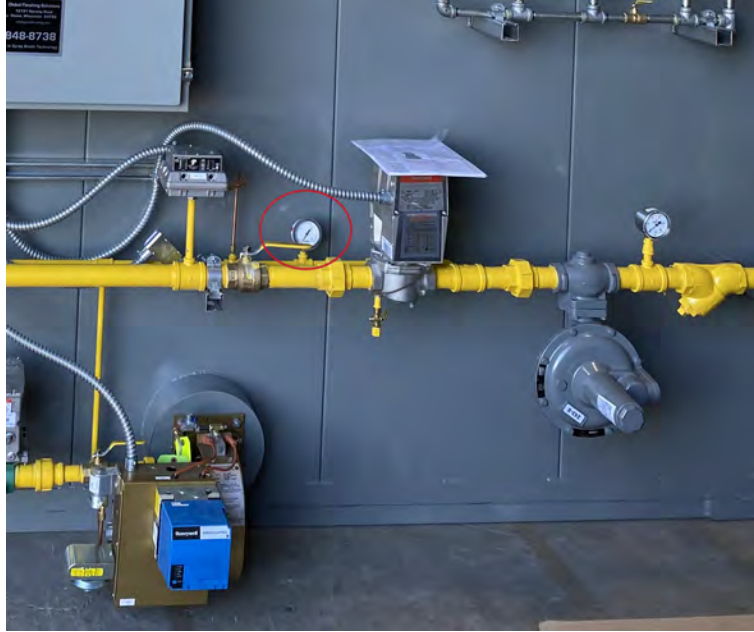

- c. Replace the regulator cap.
- 7. After holding at 300 °F, the oven will ramp up to 550 °F over the course of 2-1/2 hours and hold that temperature for 30 minutes. Use this time to verify that the afterburner temperature is approximately 1300-1400 °F. If adjustment is needed:



- a. To increase gas flow, turn the afterburner's input adjuster cap clockwise a half turn at a time.

- b. To decrease gas flow, turn the afterburner's input adjuster cap counter-clockwise a half turn at a time.

NOTE

The afterburner temperature will be checked again in "First oven burn-off cycle" (page 26).

8. After holding at 550 °F, the oven will ramp up to 675 °F over the course of 1-1/4 hours and hold that temperature for 5-1/2 hours.
9. The burners shut off and the oven temp eventually drops down to a final cool down setpoint of 100 °F. Monitor the temperature on the control panel door.

NOTE

The length of the cool-down period varies with the size of the oven.

Oven operation

Oven operation overview

When increasing the temperature from 200-350 °F, the parts begin to release VOCs into the oven. If the temperature ramps too quickly through this range, VOCs may release rapidly, supplying excess fuel to the oven, and quickly increasing its temperature. If the temperature exceeds the setpoint by 20 °F, the water spray will activate. If the initial spray is unable to control the oven temperature, and the oven exceeds setpoint temperature by 40 °F, the Oven Excess Temperature Controller switch will trip.

Typically, when this happens it is due to the parts reaching flash point. Parts reach flash point when VOCs release too quickly, creating a high enough concentration for the parts to combust. If an excess temperature fault occurs, silence the horn, allow time for the oven/afterburner to drop back below the setpoint temperature, then press reset on the Oven Temperature Controller to relight the burner. You need not reopen the oven door to continue the cycle.







VOC concentration is dependent on the thickness of the coatings and the total load in the oven. Some batches may need to process at lower temperatures for a longer period, and some may process at higher temperatures for a shorter time. The objective is to gradually release VOCs, while not allowing the parts to reach flash point. Profiles should be modified as each process requires. It is best to keep part loads consistent. If part loads are expected to vary, more profiles can be programmed to suit each specific load size.

To program new oven profile, see “Add/modify profile” (page 29).

First oven burn-off cycle

Prerequisite: Review “Loading capacities and limitations” (page 21) prior to starting the oven's first burn-off cycle.

The first burn-off cycle is a 6-1/2 hour profile that operates as follows:

1. Once the oven is ready for its first burn-off cycle (with a part load), select the default profile (P1 . 00) at the Oven Temperature Controller.
 - a. At the Oven Temperature Controller, press the  buttons at the same time to reset the controls.
 - b. Press  to display the current profile and segment number.
 - c. Use the  buttons to select the P1 . 00 profile.
 - d. Press  to access the Mode screen.
 - e. Use the  buttons to select Run mode.
 - f. Press and hold  for 5 seconds, until the Run light is illuminated and the oven starts.
2. Make sure the following events occur:

- The following lights illuminate:
 - Oven Gas On
 - Afterburner Gas On
 - Safety Switches On
 - Door Open
 - The Alarm Silenced light turns off.
 - Verify that the spray water is functioning. A spray water check will automatically occur approximately 48 seconds after you push the **Run** button.
 - If the spray water is not functioning, refer to “Troubleshooting” (page 38).
 - If the spray water is verified, close and latch the door.
3. Use the “Oven log sheet” (page 40) to monitor the first cycle.

NOTE

GFS recommends recording notes every half hour.

4. Ramp up to 400 °F (profile time starts once setpoint temperature is reached).
5. Take one hour to ramp to 550 °F and hold for 30 minutes. Once the setpoint temperature is reached, verify that the afterburner temperature is approximately 1400-1500 °F.
6. If adjustment is needed, increase/decrease gas flow a half turn at a time at the afterburner’s input adjuster cap.
7. The oven will then take 2 hours to ramp to 750 °F and hold for 3 hours. Monitor this ramp segment closely as this is most likely when an excess temperature alarm may occur. See Table 4 for the recommended adjustment to to profile.

Table 4. Profile Adjustment Guide

Occurrence	Adjustment
Oven high limits during ramp up reach 750 °F	1. Note when — and at what temperature — the oven temperature begins to rapidly increase (known as the run away temperature). 2. Add segment to hold for 1 hour at 50 °F below the run away temperature. 3. If the issue continues, repeat step 1.
The coating on the parts is not fully burned off at the end of the profile.	Increase the 750 °F dwell time by 1 or 2 hours, depending on the remaining coating load.

NOTE









If problems persist, contact GFS technical services.

8. Remove parts from the oven when they reach a safe handling temperature. Parts should have no more than a powdery ash residue remaining on them. If that is not the case, you will need to adjust the program.

NOTE

Some adjustment to the profile is expected to accommodate each specific part load.









Normal oven cycles

1. At the Oven Temperature Controller, select the desired burn-off profile.
 - a. Press the   buttons at the same time to reset the controls.
 - b. Press the  buttons to display the current profile and segment number.
 - c. Use the   buttons to enter the profile and segment number to select the desired profile.
 - d. Press  to access the Mode screen.
 - e. Use the   buttons to select Run mode.
 - f. Press and hold  for 5 seconds, until the Run light is illuminated and the unit starts.
2. Make sure the following events occur:
 - The following lights illuminate:
 - Oven Gas On
 - Afterburner Gas On
 - Safety Switches On
 - Door Open
 - The Alarm Silenced light turns off.
 - Verify that the spray water is functioning. A spray water check will automatically occur approximately 48 seconds after you push the **Run** button.
 - If the spray water is not functioning, refer to “Troubleshooting” (page 38).
 - If the spray water is verified, close and latch the door.

When these conditions are met, the burners will drive to high fire and carry out the selected profile. When the program is complete, both burners will shut off and the alarm will sound.

Pause/resume profile

Perform the steps below on the Oven Temperature Controller to pause a profile and resume oven operation.



1. Press  to get the Mode selector.
2. Use the   buttons until Hold displays on the screen.
3. Press and hold the  button for 5 seconds.
4. To resume the profile, press  to access the Mode selector.
5. Use the   buttons until Run displays on the screen.
6. Press and hold the  button for 5 seconds.

Stop/cancel profile

Perform the steps below on the Oven Temperature Controller to cancel a profile and stop oven operation.

CAUTION

Oven temperatures may exceed 700 °F (370 °C), refer to the Oven Temperature Controller and use caution before opening the oven doors or handling parts.



1. Press  to get the Mode selector.
2. Use the  buttons until Stat (static mode) displays on the screen.
3. Press and hold the  button for 5 seconds.

Alternatively, a profile can be canceled by pressing the Stop/Reset pushbutton on the control panel:



Add/modify profile

Perform the steps below on the Oven Temperature Controller to add or modify an oven profile.

1. Press and hold the  buttons at the same time to reset the controls.
2. Press  to display the current profile and segment number.
The first segment is typically P_ . 00.
3. Use the  buttons to select the desired profile. If creating a new profile, select an unused number between P2 . 00–P8 . 00.
4. Following the sequence in the images below, input the desired values for target setpoint temperatures, ramp times, and dwell times.

















NOTE















The total number of segments depends on the amount of material and its arrangement in the oven. Large batches may require multiple segments to gradually increase the temperature compared to smaller batches. It may also be possible to achieve the same end result with fewer segments by extending the ramp rates and dwell times.













IMPORTANT













Segments 0-2 must be repeated for all new profiles. The segments following can be modified as required for each process, but these first three segments (0, 1, and 2) are there to verify proper operation of the spray nozzles which are essential for safe operation of the system.

Table 5. New profile template

Controller Display	Description	Set Value	Press When Complete
PROF <i>PrOF</i>	Profile number selected for view	<i>P_.00</i>	
HBBD <i>Hb.bd</i>	Holdback band	<i>10</i>	
STSP <i>St.SP</i>	Start setpoint value	<i>70</i>	
RMPU <i>rmp.u</i>	Unit for ramp segment	<i>HH.mm</i>	
DLLU <i>dLL.u</i>	Unit for dwell segment	<i>HH.mm</i>	
Segment 0			
SGNO <i>SG.no</i>	Segment number	<i>0</i>	
SGTY <i>SG.tY</i>	Segment type for the selected segment number	<i>rRmP</i>	
TGSP <i>tG.SP</i>	Target setpoint for ramp segment	<i>0</i>	
RTRR <i>rtr.r</i>	Time duration or ramp rate for ramp segment	<i>00.00</i>	
P2EV <i>P2.EV</i>	States assignment of PID selection	<i>00 10</i>	
HBTY <i>Hb.tY</i>	Holdback type ¹	<i>aFF</i>	
Segment 1			
SGNO <i>SG.no</i>	Segment number	<i>1</i>	
SGTY <i>SG.tY</i>	Segment type for the selected segment number	<i>dLL</i>	
DLLT <i>dLL.t</i>	Duration time for dwell segment	<i>00.0 1</i>	
P2EV <i>P2.EV</i>	States assignment of PID selection	<i>00 10</i>	
HBTY <i>Hb.tY</i>	Holdback type ¹	<i>aFF</i>	

Controller Display	Description	Set Value	Press When Complete
Segment 2			
SGNO <i>SG.no</i>	Segment number	<i>2</i>	
SGTY <i>SG.ty</i>	Segment type for the selected segment number	<i>rRmP</i>	
TGSP <i>tG.SP</i>	Target setpoint for ramp segment	<i>100</i>	
RTRR <i>rT.r</i>	Time duration or ramp rate for ramp segment	<i>00.00</i>	
P2EV <i>P2.EV</i>	States assignment of PID selection	<i>00 10</i>	
HBTY <i>Hb.ty</i>	Holdback type ¹	<i>aFF</i>	
Segment 3			
SGNO <i>SG.no</i>	Segment number	<i>3</i>	
SGTY <i>SG.ty</i>	Segment type for the selected segment number	<i>rRmP</i>	
TGSP <i>tG.SP</i>	Target setpoint for ramp segment is 300-450 °F for the first ramp to allow for the gradual decomposition of material NOTE Monitor for the VOC ignition flash point. For more information, see "Oven operation overview" (page 26).		
RTRR <i>rT.r</i>	Time duration or ramp rate for ramp segment. Large temperature changes may require extended ramp rates.		
P2EV <i>P2.EV</i>	States assignment of PID selection	<i>00 10</i>	
HBTY <i>Hb.ty</i>	Holdback type ¹	<i>bRnD</i>	
Segment 4			
SGNO <i>SG.no</i>	Segment number	<i>4</i>	
SGTY <i>SG.ty</i>	Segment type for the selected segment number	<i>dLL</i>	
DLLT <i>dLL.t</i>	Duration time for dwell segment. The recommended dwell time is 1 to 5 hours. The minimum dwell time is 00.01.	<i>HH.mm</i>	

Controller Display	Description	Set Value	Press When Complete
P2EV <i>P2.EV</i>	States assignment of PID selection	00 10	
HBTY <i>Hb.tY</i>	Holdback type ¹	<i>bRnd</i>	
Segment 5			
SGNO <i>SG.no</i>	Segment number	5	
SGTY <i>SG.tY</i>	Segment type for the selected segment number	<i>rRmP</i>	
TGSP <i>tG.SP</i>	Target setpoint for ramp segment is 300-750 °F. The setpoint should be higher than the preceding segment setpoints.		
RTRR <i>r.t.rR</i>	Time duration or ramp rate for ramp segment. The recommended ramp time is 1 to 5 hours.	<i>HH.mm</i>	
P2EV <i>P2.EV</i>	States assignment of PID selection	0 100	
HBTY <i>Hb.tY</i>	Holdback type ¹	<i>bRnd</i>	
Segment 6			
SGNO <i>SG.no</i>	Segment number	<i>b</i>	
SGTY <i>SG.tY</i>	Segment type for the selected segment number	<i>dLL</i>	
DLT <i>dLL.t</i>	Duration time for dwell segment. The recommended dwell time is 1 to 5 hours. The minimum dwell time is 00.01.	<i>HH.mm</i>	
P2EV <i>P2.EV</i>	States assignment of PID selection	00 10	
HBTY <i>Hb.tY</i>	Holdback type ¹	<i>bRnd</i>	
Segment 7			
SGNO <i>SG.no</i>	Segment number	7	
SGTY <i>SG.tY</i>	Segment type for the selected segment number	<i>rRmP</i>	
TGSP <i>tG.SP</i>	Target setpoint for ramp segment is 300-750 °F. The setpoint should be higher than the preceding segment setpoints.		

Controller Display	Description	Set Value	Press When Complete
RTRR <i>rErr</i>	Time duration or ramp rate for ramp segment. the recommended ramp time is 1 to 5 hours.	<i>HH.mm</i>	
P2EV <i>P2.EV</i>	States assignment of PID selection	<i>00 10</i>	
HBTY <i>HbTY</i>	Holdback type ¹	<i>bRnd</i>	
Segment 8			
SGNO <i>SG.no</i>	Segment number	<i>8</i>	
SGTY <i>SG.tY</i>	Segment type for the selected segment number	<i>dLL</i>	
DLT <i>dLL.t</i>	Duration time for dwell segment. The recommended dwell time is 1 to 5 hours. The minimum dwell time is 00.01.	<i>HH.mm</i>	
P2EV <i>P2.EV</i>	States assignment of PID selection	<i>00 10</i>	
HBTY <i>HbTY</i>	Holdback type ¹	<i>bRnd</i>	
End Segment			
SGTY <i>SG.tY</i>	Segment type for the selected segment number	<i>End</i>	
FSP <i>F.SP</i>	Final setpoint for the end segment	<i>150</i>	
CYCL <i>CYCL</i>	Repeat number of cycles for end segment	<i>1</i>	
HBTY <i>HbTY</i>	Holdback type ¹	<i>oFF</i>	

¹Select *bRnd* as the holdback type (*HBTY*) in each dwell and ramp segment where the setpoint temperature is 300-750 °F.

Maintenance schedule

CAUTION

All personnel involved with this equipment must be instructed in the safe conduct and operation of this unit.

Reference: Refer to the Midco Burner Installation and Service Instructions.

NOTICE

Per NFPA 86, the product must be installed and serviced only by a trained, qualified service technician. Incorrect installation may void the warranty.

Customers are responsible for developing an inspection, testing, and maintenance program to make sure that this unit is in safe working order. When adjusting the frequency of the maintenance schedule below, consider the hours of operation and the operating environment. GFS suggests keeping logs to record variations in readings to uncover trouble areas and help prevent serious problems from developing.

Preventative maintenance programs ensure safe and reliable operation and contribute to the longevity of equipment. The following chart is a suggested routine maintenance program.

Items to Be Inspected and/or Cleaned	Daily	Weekly	Monthly	Yearly
Clean ash residue from inside the oven after each cycle.	X			
Clean ash from under the burner tubes (if needed).	X			
Press the Test Cooling Water button to test the spray nozzles and the functionality of the button. If the spray nozzles do not work properly, clean or replace them.	X			
<i>If applicable:</i> Check hand valves, manual dampers, and secondary air openings/adjustable bypasses for proper positions.	X			
Check blowers for unusual bearing noise and shaft vibration.	X			
<i>If applicable:</i> Verify proper operation of ventilation equipment.	X			
Test thermocouples and lead wire for shorts and loose connections.		X		
Check setting and operation of high temperature limit device(s).		X		
NOTE Refer to "Safety checklist" (page 16) for instructions.				
Test visual and/or audible alarm systems for proper signals.		X		
NOTE Refer to "Safety checklist" (page 16) for instructions.				
Check all pressure switches for proper pressure settings, as defined in the Design Drawings.		X		
NOTE Refer to "Gas train components" (page 18) for information on switch settings.				
During normal operation, check valve motors and control valves or dampers for free, smooth action and adjustment.		X		
Check that explosion relief panels and door movements are unrestricted and allow proper venting.		X		

Maintenance schedule

Items to Be Inspected and/or Cleaned	Daily	Weekly	Monthly	Yearly
Inspect the insulation inside of the oven.		X		
Make sure the explosion relief door can swing freely (if needed).		X		
Inspect the door gasket for a proper seal.		X		
Test the automatic or manual turndown equipment			X	
Take apart the castors to clean and decontaminate them. NOTE GFS does not recommend greasing the casters.			X	
1. Test the interlock sequence of all safety equipment. 2. Force each interlock to fail manually. 3. Verify that the related equipment closes or stops as specified by the manufacturer. NOTE Refer to "Safety checklist" (page 16) for instructions.			X	
Visually inspect the flame safeguard.			X	
Inspect all electrical switch and flame safeguard components. Clean them if needed.			X	
Test all amplifier and thermocouple fail-safe devices, making certain that the instrument drives in the proper direction. NOTE Refer to "Safety checklist" (page 16) for instructions.			X	
Test the main fuel hand valves for proper operation.			X	
Test the pressure switch settings by checking switch movement against pressure settings and comparing with actual impulse pressure. NOTE Refer to "Safety checklist" (page 16) for instructions.			X	
Visually check to ensure that the inlet screen and blower wheel are free of dust and lint accumulation.			X	
Clean the gas strainers. Refer to "Water train components" (page 19) for location information.			X	
Clean the valve seats. Make sure the valves move freely.			X	
Check the burners for proper ignition and combustion characteristics. Visually ascertain the presence of a flame after the burner lights.			X	
Check the pilots and/or spark plugs for proper main burner ignition.			X	
Inspect the burners and pilots (clean if necessary).			X	
Check all orifice plates, air-gas mixtures, flow indicators, meters, gauges, and pressure indicators (clean or repair if necessary).			X	
Check the ignition cable and transformers. NOTE The ignition transformer is located in the burner electrical panel.			X	
Test the automatic or manual turndown equipment.			X	
Perform the safety shut-off valve leak test and verify that the safety shut-off valves close tightly. NOTE Refer to "Perform the valve leak test" (page 36) for instructions.				X
Calibrate all instrumentation to ensure proper readings.				X

Perform the valve leak test

Scope: This task checks the closure tightness of a gas safety shutoff valve and should be performed by qualified personnel during the initial startup of a burner system, at least annually thereafter, and whenever the valve or valve bonnet is replaced.

Prerequisites: Prior to performing the valve leak test, and with the appliance running, apply an all-purpose liquid leak detector and bubble test all gas train components and fittings downstream of the main shut-off valve (G). The presence of bubbles indicates a leak. Tighten the fittings before proceeding.

Reference: Refer to the diagrams in “Gas train components” (page 18) while completing this procedure.

1. Disable the burner system and make sure the safety shut-off valves are closed via the visual indicators.
2. Close the upstream shut-off valve (G) and both downstream manual test ball valves (L).
3. Remove the cap on the valve 1 test port (H) and connect the test apparatus to the test port.

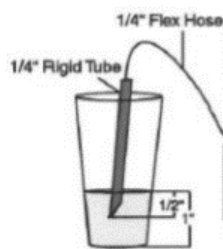
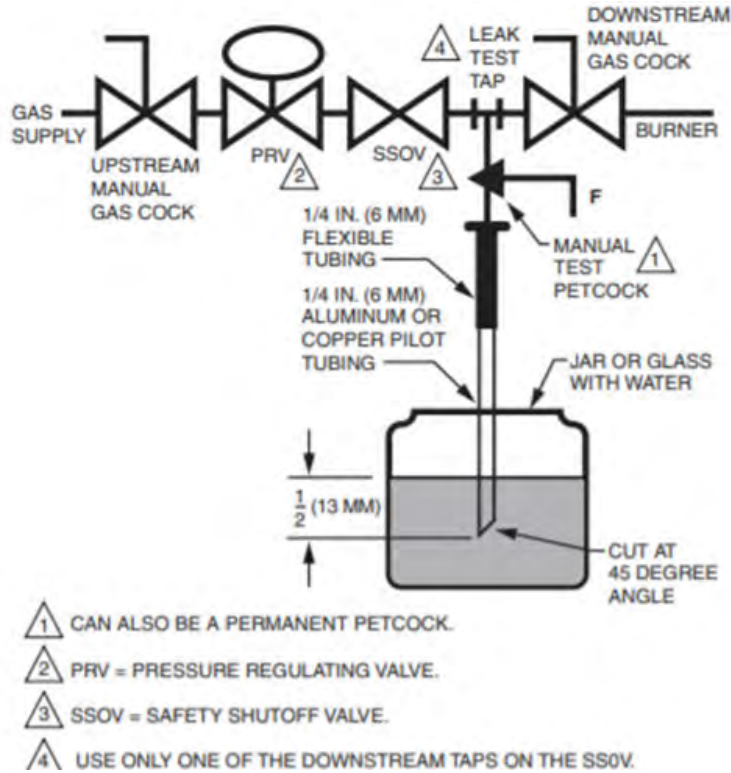

Figure 4. Test apparatus detail

4. Open the upstream shut-off valve (G).
5. Allow some time for potential leakage to charge the plumbing before measuring the valve seat leakage.

NOTE

Safety shut-off valve 1 (D) must be energized (open) when testing the secondary safety shut-off valves (I).



6. Immerse a 1/4-inch tube vertically 1/2-inch into a glass or jar of water.
7. Slowly open the valve 1 test port (H).
8. When the rate of bubbles coming through the water stabilizes, count the number of bubbles appearing during a ten-second period. Each bubble appearing during a ten second period represents a flow rate of approximately 0.001 cfh.

NOTE

To meet U.S. requirements, leakages must not exceed the values listed in Table 6. For international leak test requirements, contact the local authority.

Table 6. Leakage Values

V5055 Pipe Size (inches)	Gas Specific Gravity	Allowable Leakage (cc/hr) ¹	Maximum Number of Bubbles per 10 Seconds	Minimum Number of Seconds for 10 Bubbles
3/4-inch through 1-1/2-inches	0.64 Natural Gas	573	14	6.7
	1.57 Propane	366	9	10.5

¹Based on standard conditions, test pressure provided by ANSI Z21.21, Section 2.4.2 and a maximum of 235 cc/hr (air) per inch of seal-off diameter. Seal-off diameter is not to be confused with pipe size.

9. Close the upstream shutoff valve (G).
10. Close the valve 1 test port (H), remove the test apparatus, and replace the cap.
11. Repeat this process for each in of the secondary safety shut-off valves (I).

NOTE

There is one on each of the oven and afterburner valve trains.

Troubleshooting

Use this table to troubleshoot a Batch Burn-Off Oven that is not operating as expected.

Symptom	Probable Cause	Remedy
You cannot initiate a startup sequence.	A motor overload has been tripped.	<ol style="list-style-type: none"> 1. Reset the motor overload switches. 2. Check the amp draw.
	The oven doors are open.	<p>Close the oven door.</p> <p>NOTE The doors will be open before and at the beginning of the cycle. Refer to "Normal oven cycles" (page 28) for more information.</p>
The startup sequence is initiated, but the burner does not light.	An airflow switch has not made contact.	<ol style="list-style-type: none"> 1. Check the airflow switch adjustment. 2. Check the rotation of the blower. 3. Check the outlet pressure from the blower.
	The high or low gas pressure switch has activated.	<ol style="list-style-type: none"> 1. Check the incoming gas pressure and adjust if necessary. 2. Check the pressure switch setting and operation.
	There is air in the gas line. WARNING Make sure the power is off to the unit and no sparks or open flames are present before you bleed the gas line.	<p>Bleed the gas line:</p> <ol style="list-style-type: none"> 1. Close the manual gas valve. 2. Remove the drip leg cap and slowly open the gas valve until you can smell gas; then close the gas valve immediately. 3. Replace the drip leg cap and slowly open the gas valve. GFS recommends checking for gas leaks a second time.
	Weak igniter flame	<ol style="list-style-type: none"> 1. View igniter flame through the peep hole on burner. 2. Adjust igniter regulator screw to achieve a stable flue flame which burns firmly within the igniter tip.
The oven is not reaching temperature. NOTE The afterburner temperature must be above 1200 °F for the oven temperature to exceed 300 °F.	The linkage between the modulating gas valve and motor or is disconnected.	Inspect the linkage and reconnect if necessary.
	The Oven Temperature Controller is not set correctly or the setpoints are not within the stated operating range.	Make sure that the correct profile is selected. Verify that the profile has the anticipated parameters and that it is starting from the correct segment of the profile. If modification is needed, see "Add/modify profile" (page 29).
	The cycle settings are not aggressive enough.	Some profile adjustments may be needed to accommodate the part load, see "Add/modify profile" (page 29).

Symptom	Probable Cause	Remedy
The oven is exceeding temperature.	The linkage between the modulating gas valve and motor has slipped.	Inspect the linkage and reposition if necessary.
	The Oven Temperature Controller is not set correctly or the setpoints are not within the stated operating range.	Make sure that the correct profile is selected. Verify that the profile has the anticipated parameters and that it is starting from the correct segment of the profile. If modification is needed, see "Add/modify profile" (page 29).
	The cycle settings are too aggressive.	Some profile adjustments may be needed to accommodate the part load, see "Add/modify profile" (page 29).
	Parts inside the oven are catching fire.	<ol style="list-style-type: none"> 1. Note when — and at what temperature — the oven temperature begins to rapidly increase (known as the run away temperature). 2. Add a segment to hold for 1 hour at 50 °F below the run away temperature. 3. If the issue continues, repeat steps 1 and 2.

Oven log sheet

Program Number	Number of Segments	Total Run Time

Time		Oven Temperature	Afterburner Temperature
Elapsed	Actual		